

# teho



ИСКРОБЕЗОПАСНЫЙ  
КОРРОЗИОННОСТОЙКИЙ  
НЕМАГНИТНЫЙ  
ПРОМЫШЛЕННЫЙ  
ИНСТРУМЕНТ

**teho**

ИСКРОБЕЗОПАСНЫЙ  
КОРРОЗИОННОСТОЙКИЙ  
НЕМАГНИТНЫЙ  
ПРОМЫШЛЕННЫЙ  
ИНСТРУМЕНТ

## СОДЕРЖАНИЕ

---

- 4 Гаечные ключи
- 17 Головки торцевые и принадлежности
- 21 Шарнирно-губцевый инструмент
- 23 Отвертки
- 24 Ударный инструмент
- 27 Прочий инструмент
- 29 Наборы инструментов

**КЛЮЧ КОМБИНИРОВАННЫЙ** Мод. 0075



Код		Размер		Вес, г	
Be-Cu	Al-Br	S, мм	L, мм	Be-Cu	Al-Br
347TM6	347TA6	6	105	22	20
347TM7	347TA7	7	120	37	34
347TM8	347TA8	8	120	37	34
347TM9	347TA9	9	135	55	50
347TM10	347TA10	10	135	55	50
347TM11	347TA11	11	150	75	75
347TM12	347TA12	12	150	75	70
347TM13	347TA13	13	175	122	110
347TM14	347TA14	14	175	122	110
347TM15	347TA15	15	195	160	145
347TM16	347TA16	16	195	155	140
347TM17	347TA17	17	195	155	140
347TM18	347TA18	18	215	210	190
347TM19	347TA19	19	215	210	190
347TM20	347TA20	20	230	225	200
347TM21	347TA21	21	230	225	200
347TM22	347TA22	22	245	250	220
347TM23	347TA23	23	265	265	233
347TM24	347TA24	24	265	260	230
347TM25	347TA25	25	265	260	230
347TM26	347TA26	26	290	420	380
347TM27	347TA27	27	290	420	380
347TM30	347TA30	30	320	560	500
347TM32	347TA32	32	340	670	600
347TM34	347TA34	34	360	850	750
347TM35	347TA35	35	360	890	800
347TM36	347TA36	36	360	890	800
347TM38	347TA38	38	430	1200	1150
347TM41	347TA41	41	430	1440	1300
347TM46	347TA46	46	480	1890	1700
347TM50	347TA50	50	520	2220	2000
347TM55	347TA55	55	560	2460	2230
347TM60	347TA60	60	595	3300	2950
347TM65	347TA65	65	595	3250	2900
347TM70	347TA70	70	630	4550	4100
Be-Cu	Al-Br	S, дюйм	L, мм	Be-Cu	Al-Br
347TMA1002	347TAA1002	1/4"	105	22	20
347TMA1004	347TAA1004	5/16"	120	37	34
347TMA1006	347TAA1006	3/8"	135	55	50
347TMA1008	347TAA1008	7/16"	150	75	70
347TMA1010	347TAA1010	1/2"	175	125	115
347TMA1012	347TAA1012	9/16"	175	122	110
347TMA1014	347TAA1014	19/32"	195	160	145
347TMA1016	347TAA1016	5/8"	195	155	140
347TMA1018	347TAA1018	11/16"	195	155	140
347TMA1020	347TAA1020	3/4"	215	210	190
347TMA1022	347TAA1022	13/16"	230	225	200
347TMA1024	347TAA1024	7/8"	245	250	225
347TMA1026	347TAA1026	15/16"	265	260	230

347TMA1028	347TAA1028	1"	290	420	380
347TMA1030	347TAA1030	1-1/16"	290	420	380
347TMA1032	347TAA1032	1-1/8"	320	560	500
347TMA1034	347TAA1034	1-3/16"	320	560	500
347TMA1036	347TAA1036	1-1/4"	340	670	600
347TMA1038	347TAA1038	1-5/16"	360	850	750
347TMA1040	347TAA1040	1-3/8"	360	890	800

**КЛЮЧ РОЖКОВЫЙ С ИЗГИБОМ, ОДНОСТОРОННИЙ** Мод. 0079

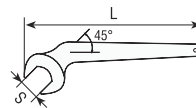
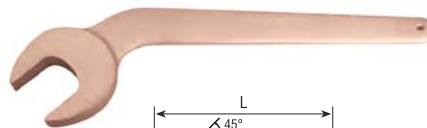

Код		Размер		Вес, г	
Be-Cu	Al-Br	S, мм	L, мм	Be-Cu	Al-Br
340TM12	340TA12	12	120	55	50
340TM14	340TA14	14	130	90	80
340TM17	340TA17	17	150	125	115
340TM19	340TA19	19	170	180	165
340TM22	340TA22	22	190	250	230
340TM24	340TA24	24	210	255	235
340TM27	340TA27	27	230	380	350
340TM30	340TA30	30	250	490	450
340TM32	340TA32	32	270	590	545
340TM34	340TA34	34	280	720	660
340TM36	340TA36	36	290	850	780
340TM41	340TA41	41	310	1090	1005
340TM46	340TA46	46	330	1340	1225
340TM50	340TA50	50	350	1615	1480
340TM55	340TA55	55	370	2135	1955

**КЛЮЧ РОЖКОВЫЙ, КОЛИКОВЫЙ** Мод. 0080



Код		Размер		Вес, г	
Be-Cu	Al-Br	S, мм	L, мм	Be-Cu	Al-Br
348TM17	348TA17	17	220	125	115
348TM19	348TA19	19	240	160	145
348TM22	348TA22	22	260	210	190
348TM24	348TA24	24	280	265	240
348TM27	348TA27	27	300	350	315
348TM30	348TA30	30	320	445	405
348TM32	348TA32	32	340	530	480
348TM36	348TA36	36	360	720	650
348TM41	348TA41	41	380	1010	910
348TM46	348TA46	46	400	1115	1010
348TM50	348TA50	50	420	1165	1055
348TM55	348TA55	55	450	1485	1345
348TM60	348TA60	60	480	2015	1825

## КЛЮЧ РОЖКОВЫЙ ОДНОСТОРОННИЙ

Мод. 0081

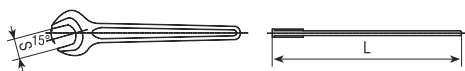

Код		Размер		Вес, г	
Be-Cu	Al-Br	S, мм	L, мм	Be-Cu	Al-Br
315TM8	315TA8	8	95	40	35
315TM10	315TA10	10	100	50	45
315TM12	315TA12	12	110	65	60
315TM14	315TA14	14	140	95	85
315TM17	315TA17	17	160	105	95
315TM19	315TA19	19	170	130	115
315TM22	315TA22	22	195	170	152
315TM24	315TA24	24	220	190	170
315TM27	315TA27	27	240	285	260
315TM30	315TA30	30	260	320	290
315TM32	315TA32	32	275	400	365
315TM34	315TA34	34	290	455	410
315TM36	315TA36	36	310	530	480
315TM41	315TA41	41	345	615	555
315TM46	315TA46	46	375	950	860
315TM50	315TA50	50	410	1080	950
315TM55	315TA55	55	450	1380	1200
315TM60	315TA60	60	490	1950	1700
315TM65	315TA65	65	530	2250	2000
315TM70	315TA70	70	570	2850	2550
315TM75	315TA75	75	610	3200	2800

## КЛЮЧ РОЖКОВЫЙ УДАРНЫЙ (DIN 133)

Мод. 0089

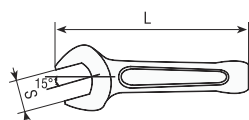

Код		Размер		Вес, г	
Be-Cu	Al-Br	S, мм	L, мм	Be-Cu	Al-Br
313TM17	313TA17	17	125	150	135
313TM19	313TA19	19	125	150	135
313TM22	313TA22	22	135	195	175
313TM24	313TA24	24	150	245	220
313TM27	313TA27	27	175	385	350
313TM30	313TA30	30	190	465	420
313TM32	313TA32	32	190	515	460
313TM36	313TA36	36	210	675	615
313TM41	313TA41	41	230	955	860
313TM46	313TA46	46	250	1225	1100
313TM50	313TA50	50	275	1560	1420
313TM55	313TA55	55	305	2025	1830
313TM60	313TA60	60	315	2345	2120
313TM65	313TA65	65	335	3060	2780
313TM70	313TA70	70	370	4030	3660
313TM75	313TA75	75	375	4660	4030
313TM80	313TA80	80	400	5650	5130
313TM85	313TA85	85	400	6000	5400

## КЛЮЧ РОЖКОВЫЙ УДАРНЫЙ (DIN 133)

Мод. 0090

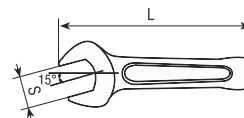

Код		Размер		Вес, г	
Be-Cu	Al-Br	S, дюйм	L, мм	Be-Cu	Al-Br
313TM1002	313TA1002	3/4"	125	150	135
313TM1004	313TA1004	7/8"	135	195	175
313TM1006	313TA1006	15/16"	150	245	220
313TM1008	313TA1008	1"	175	335	300
313TM1010	313TA1010	1-1/8"	190	435	390
313TM1012	313TA1012	1-1/4"	190	515	460
313TM1014	313TA1014	1-7/16"	210	800	730
313TM1016	313TA1016	1-1/2"	220	860	780
313TM1018	313TA1018	1-5/8"	230	955	860
313TM1020	313TA1020	1-3/4"	250	1225	1100
313TM1022	313TA1022	1-7/8"	250	1225	1100
313TM1024	313TA1024	2"	275	1550	1400
313TM1028	313TA1028	2-1/8"	305	1850	1680
313TM1030	313TA1030	2-1/4"	315	2190	1970
313TM1032	313TA1032	2-3/8"	315	2190	1970

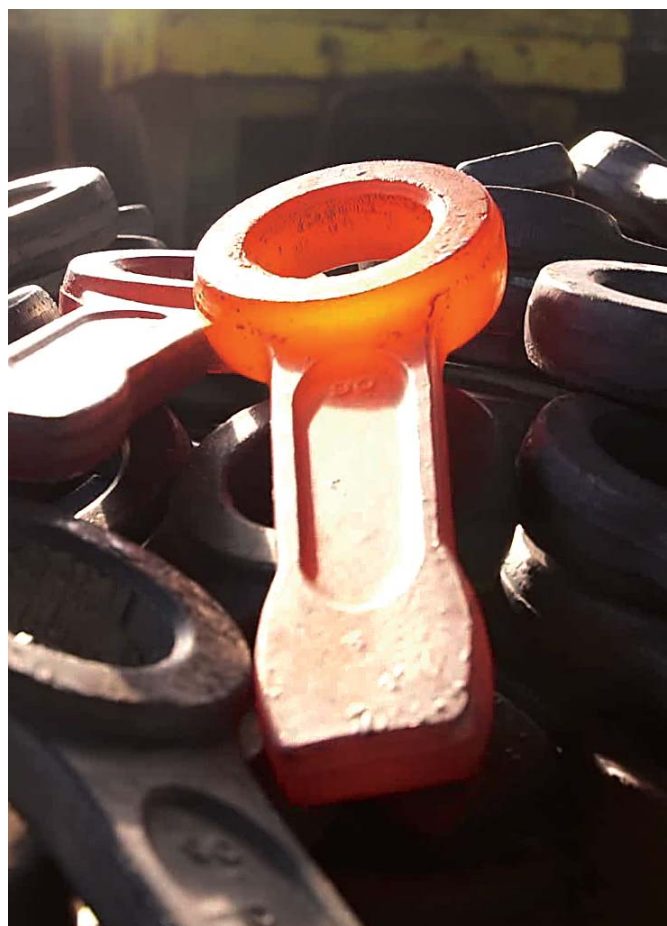

313TM1034	313TA1034	2-1/2"	335	3060	2780
313TM1036	313TA1036	2-3/4"	370	4030	3660
313TM1038	313TA1038	3"	375	4200	3800
313TM1040	313TA1040	3-1/8"	400	5650	5130
313TM1042	313TA1042	3-1/2"	445	7800	7050
313TM1044	313TA1044	3-3/4"	445	7730	7000
313TM1046	313TA1046	4"	485	11600	10500

**КЛЮЧ РОЖКОВЫЙ ДВУХСТОРОННИЙ** Мод. 0098

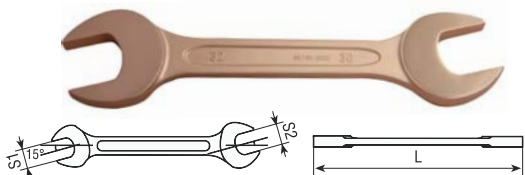

Код		Размер		Вес, г	
Be-Cu	Al-Br	S1*S2, мм	L, мм	Be-Cu	Al-Br
319TM0507	319TA0507	5.5*7	90	23	20
319TM0607	319TA0607	6*7	90	25	22
319TM0709	319TA0709	7*9	100	28	25
319TM0810	319TA0810	8*10	100	34	31
319TM0911	319TA0911	9*11	110	50	45
319TM1011	319TA1011	10*11	120	52	47
319TM1012	319TA1012	10*12	120	60	55
319TM1014	319TA1014	10*14	130	68	62
319TM1213	319TA1213	12*13	130	73	67
319TM1214	319TA1214	12*14	130	75	69
319TM1317	319TA1317	13*17	150	110	100
319TM1415	319TA1415	14*15	143	115	105
319TM1417	319TA1417	14*17	150	120	110
319TM1617	319TA1617	16*17	160	130	120
319TM1618	319TA1618	16*18	160	145	130
319TM1719	319TA1719	17*19	170	150	135
319TM1819	319TA1819	18*19	170	200	180
319TM1921	319TA1921	19*21	185	210	190
319TM1922	319TA1922	19*22	185	220	200
319TM1924	319TA1924	19*24	190	235	210
319TM2022	319TA2022	20*22	200	250	225
319TM2123	319TA2123	21*23	200	270	235
319TM2126	319TA2126	21*26	215	275	245
319TM2224	319TA2224	22*24	210	312	285
319TM2227	319TA2227	22*27	215	320	292
319TM2326	319TA2326	23*26	220	330	302
319TM2427	319TA2427	24*27	230	345	310
319TM2430	319TA2430	24*30	235	365	330
319TM2528	319TA2528	25*28	235	365	330
319TM2632	319TA2632	26*32	255	465	420
319TM2730	319TA2730	27*30	250	485	430
319TM2732	319TA2732	27*32	255	600	549
319TM3032	319TA3032	30*32	265	610	540
319TM3036	319TA3036	30*36	285	815	730
319TM3234	319TA3234	32*34	285	815	730
319TM3236	319TA3236	32*36	300	885	800
319TM3436	319TA3436	34*36	300	885	800
319TM3638	319TA3638	36*38	330	1350	1210
319TM3641	319TA3641	36*41	330	1350	1210
319TM3840	319TA3840	38*40	330	1350	1210
319TM4146	319TA4146	41*46	360	1690	1530
319TM4650	319TA4650	46*50	370	2050	1850
319TM5055	319TA5055	50*55	385	2160	1950
319TM5060	319TA5060	50*60	400	2488	2275
319TM5560	319TA5560	55*60	415	2700	2450
319TM6065	319TA6065	60*65	435	3950	3600

**КЛЮЧ НАКИДНОЙ С ИЗГИБОМ** Мод. 0103

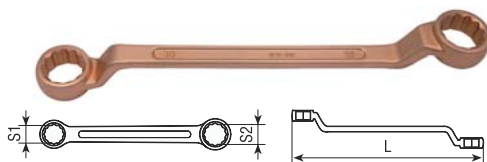

Код		Размер		Вес, г	
Be-Cu	Al-Br	S1*S2, мм	L, мм	Be-Cu	Al-Br
373TM0507	373TA0507	5.5*7	115	22	20
373TM0607	373TA0607	6*7	115	25	23
373TM0709	373TA0709	7*9	130	50	46
373TM0810	373TA0810	8*10	130	55	50
373TM0911	373TA0911	9*11	140	70	65
373TM1011	373TA1011	10*11	140	80	75
373TM1012	373TA1012	10*12	140	85	78
373TM1213	373TA1213	12*13	160	120	110
373TM1214	373TA1214	12*14	160	151	140
373TM1417	373TA1417	14*17	220	205	180
373TM1618	373TA1618	16*18	220	220	202
373TM1719	373TA1719	17*19	250	225	205
373TM1722	373TA1722	17*22	250	290	265
373TM1819	373TA1819	18*19	250	295	270
373TM1922	373TA1922	19*22	280	310	280
373TM1924	373TA1924	19*24	310	355	320
373TM2123	373TA2123	21*23	285	405	360
373TM2126	373TA2126	21*26	320	450	410
373TM2224	373TA2224	22*24	310	455	415
373TM2427	373TA2427	24*27	340	520	475
373TM2430	373TA2430	24*30	350	550	501
373TM2528	373TA2528	25*28	350	580	530
373TM2632	373TA2632	26*32	370	640	570
373TM2730	373TA2730	27*30	360	705	645
373TM3032	373TA3032	30*32	380	805	735
373TM3036	373TA3036	30*36	405	1145	1030
373TM3234	373TA3234	32*34	400	1080	980
373TM3235	373TA3235	32*36	405	1145	1030
373TM3436	373TA3436	34*36	420	1165	1065
373TM3641	373TA3641	36*41	445	1600	1465
373TM4146	373TA4146	41*46	470	2077	1905
373TM4650	373TA4650	46*50	490	2530	2315
373TM5055	373TA5055	50*55	510	2580	2360
373TM5060	373TA5060	50*60	520	3002	2745
373TM5560	373TA5560	55*60	530	3203	2905
373TM6070	373TA6070	60*70	560	4105	3605

**КЛЮЧ НАКИДНОЙ ПЛОСКИЙ, DIN837** Мод. 0108

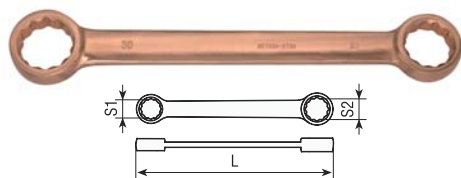

Код		Размер		Вес, г	
Be-Cu	Al-Br	S1*S2, мм	L, мм	Be-Cu	Al-Br
374TMA0810	374TAA0810	8*10	115	32	29
374TMA0911	374TAA0911	9*11	125	37	34
374TMA1012	374TAA1012	10*12	140	55	48
374TMA1214	374TAA1214	12*14	145	70	62
374TMA1417	374TAA1417	14*17	165	100	90
374TMA1719	374TAA1719	17*19	185	132	120
374TMA1922	374TAA1922	19*22	200	180	165
374TMA2224	374TAA2224	22*24	220	240	215

374TMA2427	374TAA2427	24*27	255	320	280
374TMA2730	374TAA2730	27*30	280	385	340
374TMA3032	374TAA3032	30*32	295	465	415
374TMA3236	374TAA3236	32*36	330	600	545
374TMA3641	374TAA3641	36*41	365	935	845

### КЛЮЧ НАКИДНОЙ РАЗРЕЗНОЙ

Мод. 0109

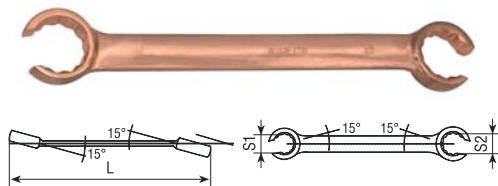

Код		Размер		Вес, г	
Be-Cu	Al-Br	S1*S2, мм	L, мм	Be-Cu	Al-Br
374TMB0607	374TAB0607	6*7	95	17	15
374TMB0810	374TAB0810	8*10	115	32	29
374TMB0911	374TAB0911	9*11	125	37	34
374TMB1012	374TAB1012	10*12	140	55	48
374TMB1214	374TAB1214	12*14	145	70	62
374TMB1415	374TAB1415	14*15	155	90	80
374TMB1417	374TAB1417	14*17	165	100	90
374TMB1618	374TAB1618	16*18	170	127	115
374TMB1719	374TAB1719	17*19	185	132	120
374TMB1922	374TAB1922	19*22	200	180	165
374TMB2224	374TAB2224	22*24	220	240	215
374TMB2427	374TAB2427	24*27	255	320	288
374TMB2430	374TAB2430	24*30	270	375	340
374TMB2528	374TAB2528	25*28	265	380	345
374TMB2730	374TAB2730	27*30	280	430	389
374TMB3032	374TAB3032	30*32	295	498	450
374TMB3034	374TAB3034	30*34	310	588	535
374TMB3036	374TAB3036	30*36	330	657	595
374TMB3436	374TAB3436	34*36	345	758	685
374TMB3641	374TAB3641	36*41	365	935	845

### КЛЮЧ НАКИДНОЙ С ИЗГИБОМ, КОЛИКОВЫЙ

Мод. 0110

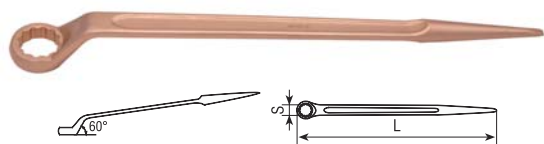

Код		Размер		Вес, г	
Be-Cu	Al-Br	S, мм	L, мм	Be-Cu	Al-Br
371TM10	371TA10	10	230	90	85
371TM12	371TA12	12	250	110	105
371TM14	371TA14	14	270	145	130
371TM17	371TA17	17	310	200	180
371TM19	371TA19	19	330	250	225
371TM22	371TA22	22	350	320	290
371TM24	371TA24	24	370	400	360
371TM27	371TA27	27	400	500	450
371TM30	371TA30	30	430	700	630
371TM32	371TA32	32	430	660	600
371TM36	371TA36	36	460	900	800
371TM41	371TA41	41	490	1090	990
371TM46	371TA46	46	520	1560	1420
371TM50	371TA50	50	540	1700	1550
371TM55	371TA55	55	560	2050	1850
371TM60	371TA60	60	610	2820	2550

### КЛЮЧ НАКИДНОЙ ОДНОСТОРОННИЙ

Мод. 0112

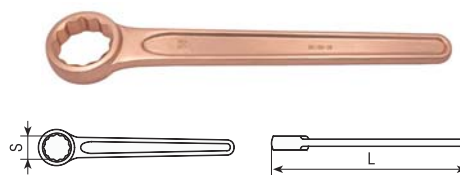

Код		Размер		Вес, г	
Be-Cu	Al-Br	S, мм	L, мм	Be-Cu	Al-Br
379TM8	379TA8	8	110	40	35
379TM10	379TA10	10	120	50	45
379TM12	379TA12	12	130	65	60
379TM14	379TA14	14	140	90	80
379TM17	379TA17	17	155	105	90
379TM19	379TA19	19	170	130	95
379TM22	379TA22	22	190	175	150
379TM24	379TA24	24	215	220	200
379TM27	379TA27	27	230	270	245
379TM30	379TA30	30	255	370	335
379TM32	379TA32	32	265	425	385
379TM36	379TA36	36	295	550	500
379TM41	379TA41	41	330	825	750
379TM46	379TA46	46	365	1120	1010
379TM50	379TA50	50	400	1270	1150
379TM55	379TA55	55	445	1590	1440
379TM60	379TA60	60	474	1850	1680
379TM65	379TA65	65	510	2060	1875
379TM70	379TA70	70	555	2530	2300
379TM75	379TA75	75	590	2700	2450

### КЛЮЧ НАКИДНОЙ СЕРПОВИДНЫЙ ДВЕНАДЦАТИГРАННЫЙ

Мод. 0115

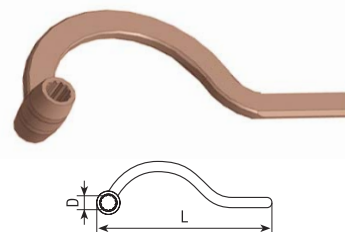

Код		Размер		Вес, г	
Be-Cu	Al-Br	D, мм	L, мм	Be-Cu	Al-Br
372TMB17	372TAB17	17	300	480	390
372TMB19	372TAB19	19	320	520	490
372TMB22	372TAB22	22	340	780	780
372TMB24	372TAB24	24	360	940	870
372TMB27	372TAB27	27	380	1050	980
372TMB30	372TAB30	30	400	1490	1380
372TMB32	372TAB32	32	420	2040	1890
372TMB36	372TAB36	36	450	2350	2170
372TMB41	372TAB41	41	510	3650	3360
372TMB46	372TAB46	46	580	4150	3850
372TMB50	372TAB50	50	610	5280	4950
372TMB55	372TAB55	55	680	5650	5300
372TMB60	372TAB60	60	730	5600	5250
372TMB65	372TAB65	65	770	6100	5700
372TMB70	372TAB70	70	820	6750	6300
372TMB75	372TAB75	75	890	7400	6900
372TMB95	372TAB95	95	1090	9050	8400

**КЛЮЧ НАКИДНОЙ С ИЗГИБОМ ОДНОСТОРОННИЙ** Мод. 0118

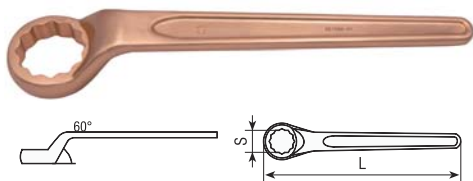

Код		Размер		Вес, г	
Be-Cu	Al-Br	S, мм	L, мм	Be-Cu	Al-Br
378TMA22	378TAA22	22	190	185	165
378TMA24	378TAA24	24	215	235	210
378TMA27	378TAA27	27	230	310	270
378TMA30	378TAA30	30	255	430	380
378TMA32	378TAA32	32	265	450	400
378TMA36	378TAA36	36	295	610	540
378TMA41	378TAA41	41	330	855	770
378TMA46	378TAA46	46	365	1000	900
378TMA50	378TAA50	50	400	1350	1200
378TMA55	378TAA55	55	445	2000	1800
378TMA60	378TAA60	60	474	2260	2050
378TMA65	378TAA65	65	510	2800	2500
378TMA70	378TAA70	70	555	3250	2900
378TMA75	378TAA75	75	590	3450	3090

**КЛЮЧ НАКИДНОЙ УДАРНЫЙ, DIN7444** Мод. 0119



Код		Размер		Вес, г	
Be-Cu	Al-Br	S, мм	L, мм	Be-Cu	Al-Br
395TM17	395TA17	17	145	210	190
395TM19	395TA19	19	145	210	190
395TM22	395TA22	22	155	245	220
395TM24	395TA24	24	165	245	220
395TM27	395TA27	27	175	350	315
395TM30	395TA30	30	185	475	430
395TM32	395TA32	32	185	475	430
395TM34	395TA34	34	200	540	490
395TM36	395TA36	36	205	580	520
395TM38	395TA38	38	215	680	620
395TM41	395TA41	41	225	755	680
395TM46	395TA46	46	235	990	890
395TM50	395TA50	50	250	1145	1030
395TM55	395TA55	55	265	1440	1300
395TM60	395TA60	60	274	1620	1450
395TM65	395TA65	65	298	1995	1800
395TM70	395TA70	70	320	2435	2200
395TM75	395TA75	75	326	3010	2720
395TM80	395TA80	80	350	3600	3250
395TM85	395TA85	85	355	4330	3915
395TM90	395TA90	90	380	5200	4700
395TM95	395TA95	95	390	5450	4920
395TM100	395TA100	100	410	6750	6100
395TM105	395TA105	105	420	7000	6320
395TM110	395TA110	110	445	9130	8250

395TM120	395TA120	120	480	11000	9930
395TM130	395TA130	130	510	12610	11400
395TM140	395TA140	140	520	13000	11750
395TM150	395TA150	150	565	14500	13100

**КЛЮЧ НАКИДНОЙ УДАРНЫЙ, DIN7444** Мод. 0121

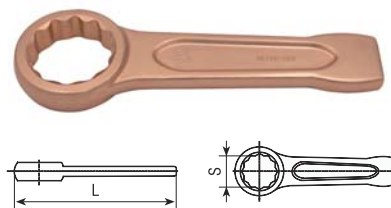

Код		Размер		Вес, г	
Be-Cu	Al-Br	S, дюйм	L, мм	Be-Cu	Al-Br
393TM1002	393TA1002	11/16"	145	210	190
393TM1004	393TA1004	3/4"	145	200	180
393TM1006	393TA1006	7/8"	155	245	220
393TM1008	393TA1008	1"	175	350	315
393TM1010	393TA1010	1-1/16"	175	350	315
393TM1012	393TA1012	1-1/8"	185	455	410
393TM1014	393TA1014	1-3/16"	185	475	430
393TM1016	393TA1016	1-1/4"	185	470	425
393TM1018	393TA1018	1-3/8"	200	560	500
393TM1020	393TA1020	1-1/2"	215	790	710
393TM1022	393TA1022	1-5/8"	225	755	680
393TM1024	393TA1024	1-3/4"	235	1020	920
393TM1026	393TA1026	1-13/16"	235	990	890
393TM1028	393TA1028	2"	250	1145	1030

**КЛЮЧ НАКИДНОЙ УДАРНЫЙ (АМЕРИКАНСКОГО ТИПА)** Мод. 0127

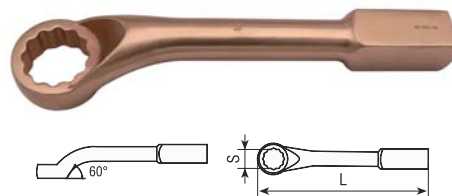

Код		Размер		Вес, г	
Be-Cu	Al-Br	S, мм	L, мм	Be-Cu	Al-Br
394TMA24	394TAA24	24	240	950	860
394TMA27	394TAA27	27	270	1150	1035
394TMA30	394TAA30	30	280	1480	1340
394TMA32	394TAA32	32	290	1690	1530
394TMA36	394TAA36	36	300	1900	1720
394TMA41	394TAA41	41	320	2110	1910
394TMA46	394TAA46	46	340	2750	2485
394TMA50	394TAA50	50	350	3170	2870
394TMA55	394TAA55	55	360	4125	3730
394TMA60	394TAA60	60	375	4335	3920
394TMA65	394TAA65	65	390	4440	4010
394TMA70	394TAA70	70	400	5400	4875
394TMA75	394TAA75	75	420	5810	5255
394TMA80	394TAA80	80	440	7295	6600
394TMA90	394TAA90	90	480	9740	8800
394TMA100	394TAA100	100	515	11300	10200
394TMA110	394TAA110	110	550	13400	12100
394TMA120	394TAA120	120	585	15500	14000
394TMA130	394TAA130	130	620	17700	16000



**КЛЮЧ НАКИДНОЙ С ИЗГИБОМ  
ОДНОСТОРОННИЙ**

Мод. 0129

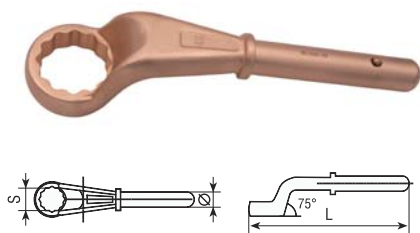

Код		Размер		Вес, г	
Ве-Сu	Al-Br	S, мм	L, мм	Ве-Сu	Al-Br
391TMA24	391TAA24	24	180	475	430
391TMA27	391TAA27	27	190	530	480
391TMA30	391TAA30	30	200	580	525
391TMA32	391TAA32	32	235	795	715
391TMA36	391TAA36	36	245	900	815
391TMA41	391TAA41	41	265	1060	955
391TMA46	391TAA46	46	280	1480	1340
391TMA50	391TAA50	50	290	1690	1530
391TMA55	391TAA55	55	300	1850	1670
391TMA60	391TAA60	60	345	2960	2670
391TMA65	391TAA65	65	355	3380	3055
391TMA70	391TAA70	70	365	3910	3530
391TMA75	391TAA75	75	375	4335	3920
391TMA80	391TAA80	80	385	5180	4680

**УДЛИНИТЕЛЬ**

Мод. 0130

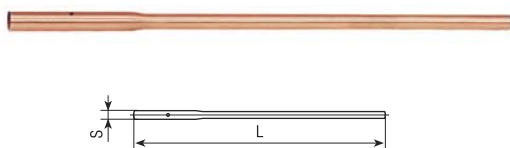

Код		Размер		Вес, г	
Ве-Сu	Al-Br	S, мм	L, мм	Ве-Сu	Al-Br
61TM30	61TA30	19	460	940	850
46TM41	46TA41	22	610	1640	1480
19TM55	19TA55	25	760	2480	2240
95TM80	95TA80	30	860	3890	3515

**УДЛИНИТЕЛЬ**

Мод. 0131

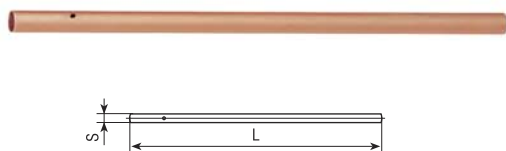

Код		Размер		Вес, г	
Copper	Brass	S, мм	L, мм	Copper	Brass
61TMA30	61TBA30	19	460	880	830
46TMA41	46TBA41	22	610	1280	1210
19TMA55	19TBA55	25	760	2125	2005
95TMA80	95TBA80	30	860	3265	3080

**КЛЮЧ ШЕСТИГРАННЫЙ**

Мод. 0136

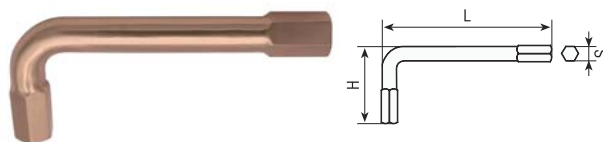

Код		Размер			Вес, г	
Ве-Сu	Al-Br	S, мм	L, мм	H, мм	Ве-Сu	Al-Br
399TM1.5	399TA1.5	1.5	38	13	8	6
399TM2	399TA2	2	38	13	8	6
399TM2.5	399TA2.5	2.5	38	13	8	6
399TM3	399TA3	3	59	25	8	7
399TM4	399TA4	4	65	30	10	8
399TM5	399TA5	5	79	32	16	12
399TM6	399TA6	6	85	37	25	20
399TM7	399TA7	7	88	43	34	30
399TM8	399TA8	8	92	44	50	45
399TM9	399TA9	9	97	44	61	55
399TM10	399TA10	10	110	45	82	70
399TM11	399TA11	11	119	48	100	90
399TM12	399TA12	12	130	52	145	130
399TM13	399TA13	13	140	54	180	160
399TM14	399TA14	14	150	58	211	191
399TM15	399TA15	15	156	60	260	230
399TM16	399TA16	16	162	63	300	270
399TM17	399TA17	17	168	65	370	335
399TM18	399TA18	18	173	69	450	402
399TM19	399TA19	19	177	72	490	445
399TM21	399TA21	21	184	74	652	595
399TM22	399TA22	22	186	77	675	615
399TM24	399TA24	24	192	82	825	755
399TM25	399TA25	25	200	84	925	840
399TM26	399TA26	26	206	90	1025	940
399TM27	399TA27	27	213	93	1220	1115
399TM28	399TA28	28	222	95	1350	1235
399TM30	399TA30	30	240	105	1615	1475
399TM32	399TA32	32	266	116	2065	1885
399TM36	399TA36	36	294	128	2905	2650
399TM41	399TA41	41	320	140	4120	3760

**КЛЮЧ ШЕСТИГРАННЫЙ**

Мод. 0137

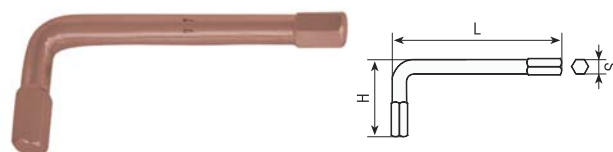

Код		Размер			Вес, г	
Ве-Сu	Al-Br	S, дюйм	L, мм	H, мм	Ве-Сu	Al-Br
392TM1002	392TA1002	1/16"	59	25	8	6
392TM1004	392TA1004	5/64"	59	25	8	6
392TM1006	392TA1006	3/32"	59	25	8	6
392TM1008	392TA1008	7/64"	59	25	8	6
392TM1010	392TA1010	1/8"	59	25	8	6
392TM1012	392TA1012	9/64"	64	29	8	7
392TM1014	392TA1014	5/32"	65	30	10	9
392TM1016	392TA1016	3/16"	79	31	15	14
392TM1018	392TA1018	7/32"	85	37	20	18
392TM1020	392TA1020	1/4"	85	37	30	27
392TM1022	392TA1022	9/32"	88	43	45	40
392TM1024	392TA1024	5/16"	92	44	48	44
392TM1026	392TA1026	11/32"	97	44	50	45

392TM1028	392TA1028	3/8"	110	45	85	80
392TM1030	392TA1030	7/16"	119	48	110	100
392TM1032	392TA1032	1/2"	140	55	170	155
392TM1034	392TA1034	9/16"	150	58	195	180
392TM1036	392TA1036	5/8"	162	63	270	245
392TM1038	392TA1038	11/16"	168	65	355	325
392TM1040	392TA1040	3/4"	178	73	450	415
392TM1042	392TA1042	13/16"	184	77	565	520
392TM1044	392TA1044	7/8"	187	79	650	595
392TM1046	392TA1046	15/16"	192	82	825	755
392TM1048	392TA1048	1"	200	85	925	840
392TM1050	392TA1050	1-1/16"	213	93	1220	1115

**КЛЮЧ ШЕСТИГРАННЫЙ** Мод. 0140

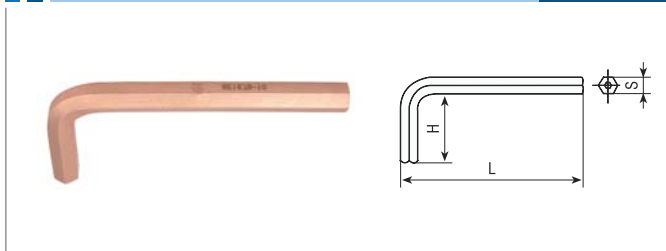

Код		Размер			Вес, г	
Be-Cu	Al-Br	S, мм	L, мм	H, мм	Be-Cu	Al-Br
392TMB2	392TAB2	2	50	16	3	2
392TMB3	392TAB3	3	63	20	5	4
392TMB4	392TAB4	4	70	25	12	11
392TMB5	392TAB5	5	80	28	22	20
392TMB6	392TAB6	6	90	32	30	27
392TMB7	392TAB7	7	95	34	50	45
392TMB8	392TAB8	8	100	36	56	50
392TMB9	392TAB9	9	106	38	85	77
392TMB10	392TAB10	10	112	40	100	90
392TMB11	392TAB11	11	118	42	140	126
392TMB12	392TAB12	12	125	45	162	145

**КЛЮЧ Г-ОБРАЗНЫЙ С ПРОФИЛЕМ TORX** Мод. 0142

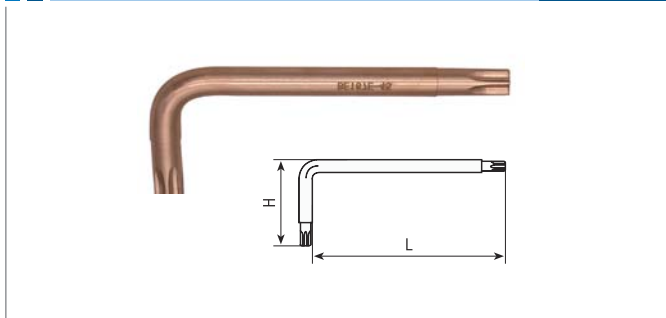

Код		Размер		Вес, г	
Be-Cu	Al-Br	Size	L, мм	Be-Cu	Al-Br
392TME6	392TAE6	TX6	42	8	5
392TME7	392TAE7	TX7	48	8	5
392TME8	392TAE8	TX8	48	8	5
392TME9	392TAE9	TX9	48	8	5
392TME10	392TAE10	TX10	51	8	5
392TME15	392TAE15	TX15	54	10	8
392TME20	392TAE20	TX20	57	13	10
392TME25	392TAE25	TX25	60	17	13
392TME27	392TAE27	TX27	64	20	15
392TME30	392TAE30	TX30	70	30	25
392TME40	392TAE40	TX40	76	40	35
392TME45	392TAE45	TX45	83	50	45
392TME50	392TAE50	TX50	95	75	65
392TME55	392TAE55	TX55	108	145	130
392TME60	392TAE60	TX60	120	210	190

**КЛЮЧ ВЕНТИЛЬНЫЙ, С-ОБРАЗНЫЙ** Мод. 0144

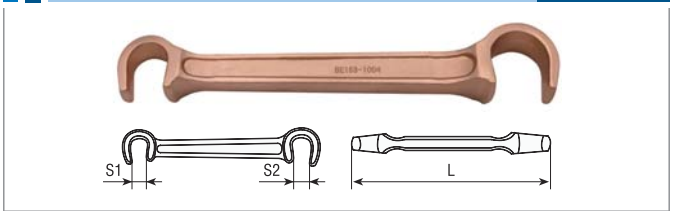

Код		Размер			Вес, г	
Be-Cu	Al-Br	L, мм	S1, мм	S2, мм	Be-Cu	Al-Br
398TM1002	398TA1002	200	14,5	18,5	370	335
398TM1004	398TA1004	250	17,5	25,5	635	575
398TM1006	398TA1006	450	25,5	34	2385	2160

**КЛЮЧ ВЕНТИЛЬНЫЙ, С-ОБРАЗНЫЙ** Мод. 0145

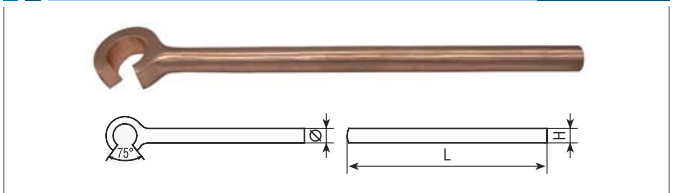

Код		Размер			Вес, г	
Be-Cu	Al-Br	L, мм	Ø, мм	H, мм	Be-Cu	Al-Br
325TM1002	325TA1002	600	32	32	4500	4115

**КЛЮЧ ВЕНТИЛЬНЫЙ, U-ОБРАЗНЫЙ** Мод. 0146

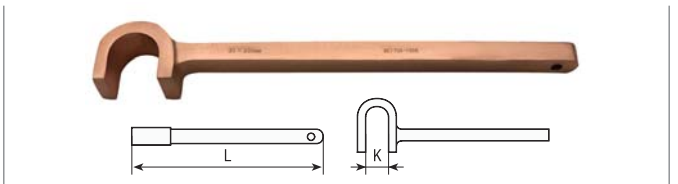

Код		Размер		Вес, г	
Be-Cu	Al-Br	L, мм	Kmax, мм	Be-Cu	Al-Br
325TMA1002	325TAA1002	234	20	260	235
325TMA1004	325TAA1004	280	30	820	740
325TMA1006	325TAA1006	335	35	980	885
325TMA1008	325TAA1008	400	35	1640	1480

**КЛЮЧ ВЕНТИЛЬНЫЙ, U-ОБРАЗНЫЙ** Мод. 0147

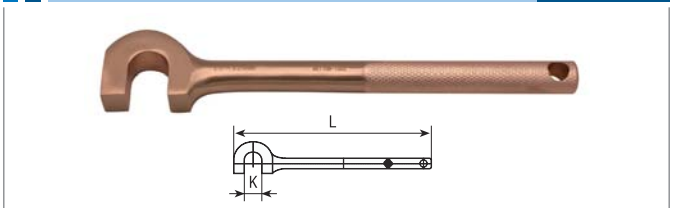

Код		Размер		Вес, г	
Be-Cu	Al-Br	L, мм	Kmax, мм	Be-Cu	Al-Br
325TMB1002	325TAB1002	226	20	370	335

**КЛЮЧ ДЛЯ КИСЛОРОДНЫХ БАЛЛОНОВ** Мод. 0148

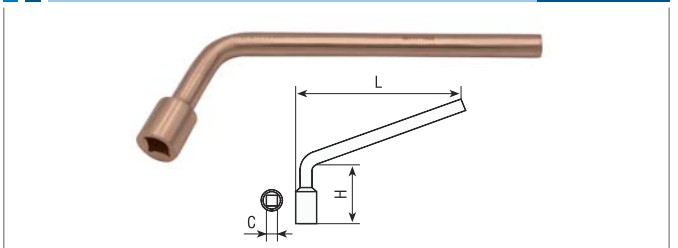

Код		Размер			Вес, г	
Be-Cu	Al-Br	C, дюйм	L, мм	H, мм	Be-Cu	Al-Br
323TM1002	323TA1002	3/8	154	58	185	170

### КЛЮЧ ШЕСТИГРАННЫЙ С ПЕРЕМЕЩАЮЩЕЙСЯ Т-ОБРАЗНОЙ РУКОЯТКОЙ Мод. 0149

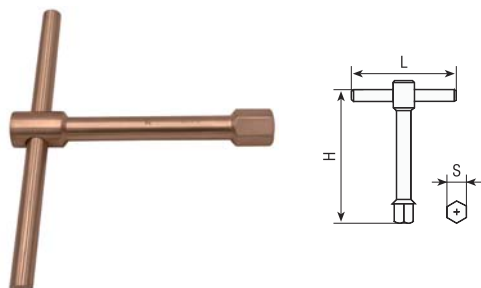

Код		Размер			Вес, г	
Be-Cu	Al-Br	S, мм	L, мм	H, мм	Be-Cu	Al-Br
326TM10	326TA10	10	150	110	270	245
326TM12	326TA12	12	170	130	290	265
326TM14	326TA14	14	170	140	400	365
326TM17	326TA17	17	190	150	465	423
326TM19	326TA19	19	220	160	615	563
326TM22	326TA22	22	240	170	660	605
326TM24	326TA24	24	260	180	935	855
326TM27	326TA27	27	260	190	1000	915
326TM30	326TA30	30	280	200	1306	1195
326TM32	326TA32	32	280	210	1505	1375
326TM36	326TA36	36	300	216	1802	1645
326TM41	326TA41	41	300	226	2075	1895

### КЛЮЧ ДЛЯ ШЛИЦЕВЫХ ГАЕК Мод. 0150

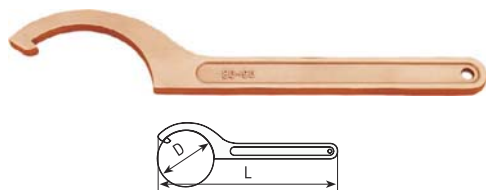

Код		Размер		Вес, г	
Be-Cu	Al-Br	D, мм	L, мм	Be-Cu	Al-Br
324TM1002	324TA1002	30-32	140	63	50
324TM1004	324TA1004	34-36	170	95	85
324TM1006	324TA1006	40-42	176	105	95
324TM1008	324TA1008	45-50	209	160	145
324TM1010	324TA1010	52-55	212	170	150
324TM1012	324TA1012	58-62	244	225	200
324TM1014	324TA1014	68-75	250	265	240
324TM1016	324TA1016	80-90	284	375	335
324TM1018	324TA1018	95-100	288	415	370
324TM1020	324TA1020	110-115	337	770	690
324TM1022	324TA1022	120-130	343	770	690
324TM1024	324TA1024	135-145	388	1110	1000

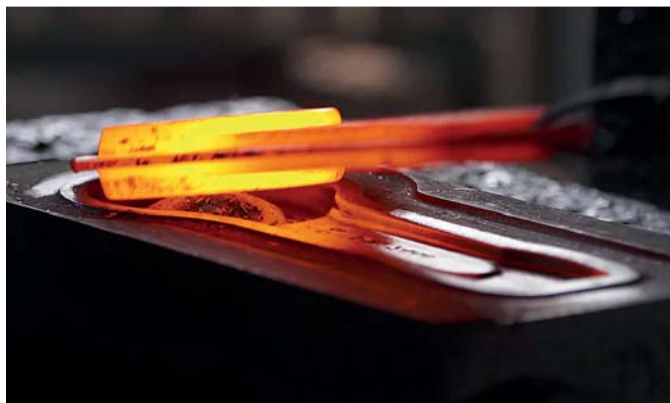

### КЛЮЧ ДЛЯ ШЛИЦЕВЫХ ГАЕК С ШАРНИРОМ Мод. 0152



Код		Размер		Вес, г	
Be-Cu	Al-Br	D, мм	L, мм	Be-Cu	Al-Br
324TMB1002	324TAB1002	19-50	162	120	110
324TMB1004	324TAB1004	32-75	205	260	235
324TMB1006	324TAB1006	50-120	288	515	460
324TMB1008	324TAB1008	115-170	310	670	600

### КЛЮЧ ДЛЯ ШЛИЦЕВЫХ ГАЕК СО ШТИФТОМ Мод. 0153



Код		Размер		Вес, г	
Be-Cu	Al-Br	D, мм	L, мм	Be-Cu	Al-Br
324TMC1002	324TAC1002	30-32	136	63	50
324TMC1004	324TAC1004	34-36	171	95	85
324TMC1006	324TAC1006	40-42	171	105	95
324TMC1008	324TAC1008	45-50	207	160	145
324TMC1010	324TAC1010	52-55	207	170	150
324TMC1012	324TAC1012	58-62	243	225	200
324TMC1014	324TAC1014	68-75	243	265	240
324TMC1016	324TAC1016	80-90	281	375	335
324TMC1018	324TAC1018	95-100	281	415	370
324TMC1020	324TAC1020	110-115	333	770	690

### КЛЮЧ ВЕНТИЛЬНЫЙ Мод. 0154

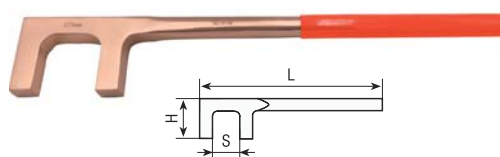

Код		Размер			Вес, г	
Be-Cu	Al-Br	S, мм	L, мм	H, мм	Be-Cu	Al-Br
321TM30	321TA30	30	200	44	405	340
321TM35	321TA35	35	250	49	465	410
321TM40	321TA40	40	300	50	595	540
321TM45	321TA45	45	350	61	835	762
321TM48	321TA48	48	375	62	865	790
321TM50	321TA50	50	400	67	892	815
321TM55	321TA55	55	450	73	1270	1110
321TM60	321TA60	60	500	79	1570	1435
321TM65	321TA65	65	550	80	1920	1755
321TM70	321TA70	70	600	80	1945	1775
321TM75	321TA75	75	650	85	2245	2055
321TM80	321TA80	80	700	91	2405	2190
321TM85	321TA85	85	750	97	3050	2770
321TM90	321TA90	90	800	103	3360	3060
321TM93	321TA93	93	850	107	3553	3250
321TM96	321TA96	96	900	110	3870	3515
321TM100	321TA100	100	1000	114	4170	3795
321TM103	321TA103	103	1200	120	6330	5765

**КЛЮЧ ВЕНТИЛЬНЫЙ** Мод. 0155

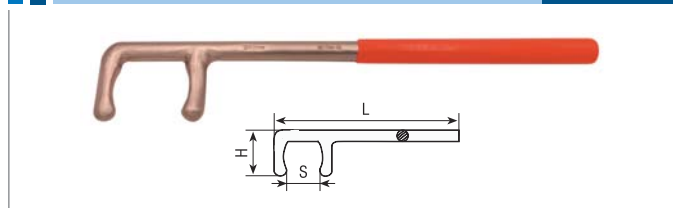

Код		Размер			Вес, г	
Be-Cu	Al-Br	S, мм	L, мм	H, мм	Be-Cu	Al-Br
321TMA30	321TAA30	30	200	46	265	240
321TMA35	321TAA35	35	250	52	375	340
321TMA40	321TAA40	40	300	54	450	400
321TMA45	321TAA45	45	350	60	585	530
321TMA50	321TAA50	50	400	68	740	670
321TMA55	321TAA55	55	450	74	830	750
321TMA60	321TAA60	60	500	80	1200	1100
321TMA65	321TAA65	65	550	83	1280	1160
321TMA70	321TAA70	70	600	88	1380	1250
321TMA75	321TAA75	75	650	93,5	1650	1500
321TMA80	321TAA80	80	700	99,5	1870	1700
321TMA85	321TAA85	85	750	100	2090	1900
321TMA90	321TAA90	90	800	107	2310	2100
321TMA96	321TAA96	95	900	112	2980	2700
321TMA100	321TAA100	100	1000	117	3330	3010

**КЛЮЧ ВЕНТИЛЬНЫЙ** Мод. 0158

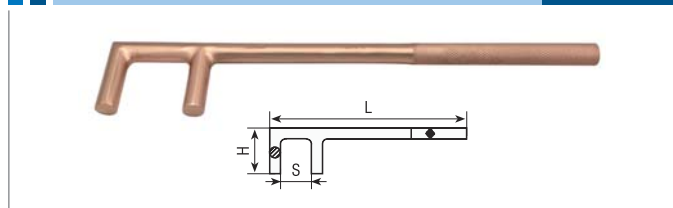

Код		Размер			Вес, г	
Be-Cu	Al-Br	S, мм	L, мм	H, мм	Be-Cu	Al-Br
329TM30	329TA30	30	200	44	280	250
329TM32	329TA32	32	300	50	540	490
329TM35	329TA35	35	250	47	364	325
329TM40	329TA40	40	300	50	470	422
329TM45	329TA45	45	350	58	610	540
329TM48	329TA48	48	375	62	660	595
329TM50	329TA50	50	400	67	705	615
329TM55	329TA55	55	450	73	960	870
329TM60	329TA60	60	500	79	1205	1105
329TM65	329TA65	65	550	82	1370	1250
329TM70	329TA70	70	600	85	1540	1360
329TM75	329TA75	75	650	88	1705	1540
329TM80	329TA80	80	700	91	1910	1650
329TM85	329TA85	85	750	97	2250	2015
329TM90	329TA90	90	800	103	2380	2130

**КЛЮЧ ВЕНТИЛЬНЫЙ** Мод. 0159

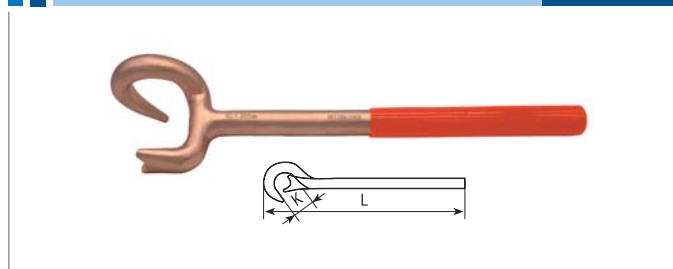

Код		Размер		Вес, г	
Be-Cu	Al-Br	K, мм	L, мм	Be-Cu	Al-Br
329TMA1002	329TAA1002	40	355	915	825

**КЛЮЧ ВЕНТИЛЬНЫЙ** Мод. 0160

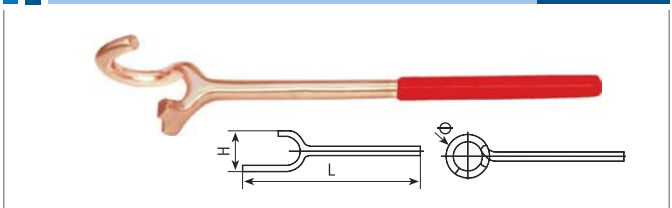

Код		Размер			Вес, г	
Be-Cu	Al-Br	B, мм	Ø, мм	L, мм	Be-Cu	Al-Br
329TMB1002	329TAB1002	60	36	370	730	650
329TMB1004	329TAB1004	80	48	430	1520	1350
329TMB1006	329TAB1006	102	62	550	2250	2000

**КЛЮЧ ВЕНТИЛЬНЫЙ** Мод. 0161

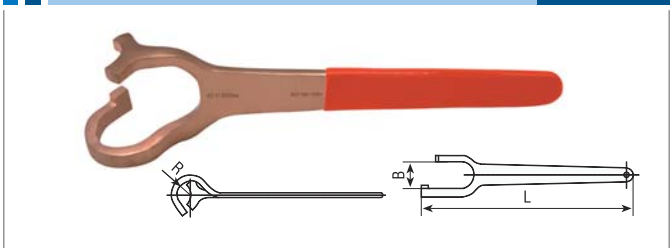

Код		Размер			Вес, г	
Be-Cu	Al-Br	B, мм	R, мм	L, мм	Be-Cu	Al-Br
329TMC1002	329TAC1002	30	15	250	415	375
329TMC1004	329TAC1004	40	20	300	540	485
329TMC1006	329TAC1006	50	25	400	1050	950
329TMC1008	329TAC1008	60	30	550	1800	1630
329TMC1010	329TAC1010	130	65	750	4900	4430

**КЛЮЧ ВЕНТИЛЬНЫЙ** Мод. 0162

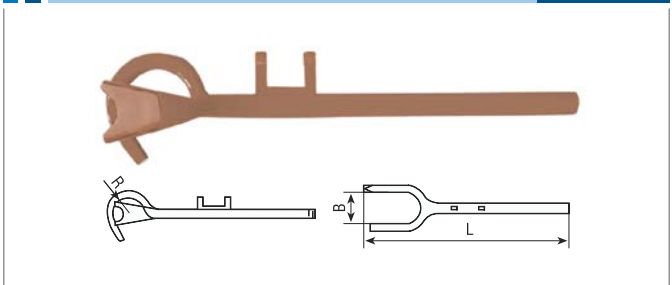

Код		Размер			Вес, г	
Be-Cu	Al-Br	B, мм	R, мм	L, мм	Be-Cu	Al-Br
329TMD1002	329TAD1002	50	22,5	290	775	700
329TMD1004	329TAD1004	60	35,5	430	1770	1580
329TMD1006	329TAD1006	80	40	520	2770	2500
329TMD1008	329TAD1008	90	45	660	4080	3660

**КЛЮЧ ВЕНТИЛЬНЫЙ** Мод. 0164

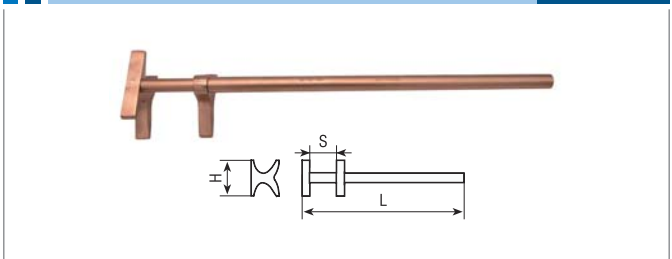

Код		Размер			Вес, г	
Be-Cu	Al-Br	S, мм	H, мм	L, мм	Be-Cu	Al-Br
329TME1002	329TAE1002	40	50	300	590	540
329TME1004	329TAE1004	55	74	450	1165	1050
329TME1006	329TAE1006	70	80	600	1950	1700
329TME1008	329TAE1008	90	100	800	2800	2600

**КЛЮЧ ВЕНТИЛЬНЫЙ**

Мод. 0165

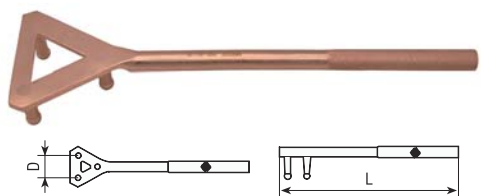

Код		Размер		Вес, г	
Ве-Сu	Al-Br	L, мм	D, мм	Ве-Сu	Al-Br
329TMF200	329TAF200	200	25	220	200
329TMF250	329TAF250	250	35	375	340
329TMF300	329TAF300	300	42	440	400
329TMF350	329TAF350	350	62	660	600
329TMF400	329TAF400	400	90	1030	940
329TMF450	329TAF450	450	110	1430	1300
329TMF500	329TAF500	500	165	2090	1900
329TMF550	329TAF550	550	225	2420	2200

**КЛЮЧ ДЛЯ ЗАВОРАЧИВАНИЯ ПРОБОК**

Мод. 0166

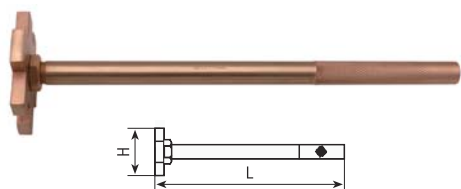

Код		Размер		Вес, г	
Ве-Сu	Al-Br	L, мм	H, мм	Ве-Сu	Al-Br
322TM1002	322TA1002	300	70	630	580

**КЛЮЧ ДЛЯ ЗАВОРАЧИВАНИЯ ПРОБОК**

Мод. 0167

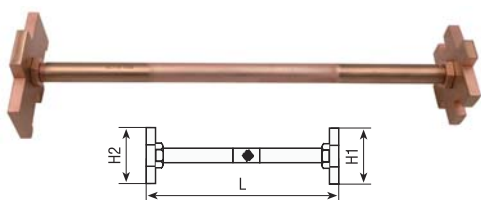

Код		Размер			Вес, г	
Ве-Сu	Al-Br	L, мм	H1, мм	H2, мм	Ве-Сu	Al-Br
320TM1002	320TA1002	350	70	95	1165	1070

**КЛЮЧ ДЛЯ ОТКРЫВАНИЯ БОЧЕК**

Мод. 0168

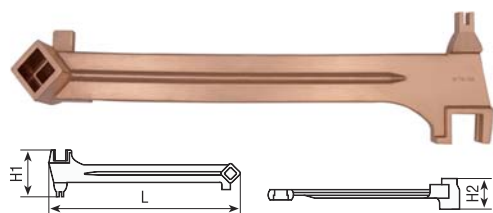

Код		Размер			Вес, г	
Ве-Сu	Al-Br	L, мм	H1, мм	H2, мм	Ве-Сu	Al-Br
328TM1002	328TA1002	385	93	61	1250	1150

**КЛЮЧ ДЛЯ ОТКРЫВАНИЯ БОЧЕК**

Мод. 0169

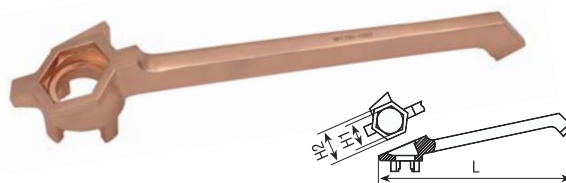

Код		Размер			Вес, г	
Ве-Сu	Al-Br	L, мм	H1, мм	H2, мм	Ве-Сu	Al-Br
328TMA1002	328TAA1002	300	38	52	830	750

**КЛЮЧ ДЛЯ ОТКРЫВАНИЯ БОЧЕК**

Мод. 0170

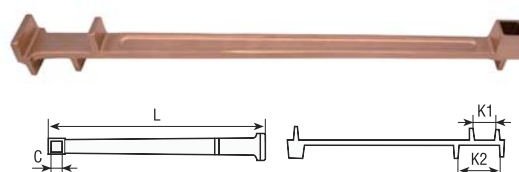

Код		Размер				Вес, г	
Ве-Сu	Al-Br	L, мм	C, мм	K1, мм	K2, мм	Ве-Сu	Al-Br
328TMB1002	328TAB1002	520	19	40	73	1120	1100

**КЛЮЧ ДЛЯ ВСКРЫТИЯ БОЧЕК**

Мод. 0171



Код		Размер	Вес, г	
Ве-Сu	Al-Br	L, мм	Ве-Сu	Al-Br
328TMC1002	328TMC1002	520	3100	2800

**КЛЮЧ С ХРАПОВИКОМ**

Мод. 0174



Код		Размер			Вес, г	
Ве-Сu	Al-Br	S, мм	L, мм	H, мм	Ве-Сu	Al-Br
303TM17	303TA17	17	290	35	720	650
303TM19	303TA19	19	300	35	850	750
303TM22	303TA22	22	320	38	995	890
303TM24	303TA24	24	329	39	1230	1100
303TM27	303TA27	27	380	39	1500	1350
303TM30	303TA30	30	433	42	1900	1600
303TM32	303TA32	32	435	42	1935	1700
303TM36	303TA36	36	487	43	2580	2320

**КЛЮЧ С ХРАПОВИКОМ** Мод. 0177

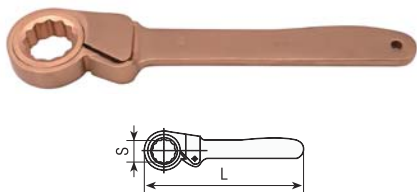

Код		Размер		Вес, г	
Be-Cu	Al-Br	S, мм	L, мм	Be-Cu	Al-Br
304TMA9	304TAA9	9	150	125	110
304TMA11	304TAA11	11	150	125	110
304TMA13	304TAA13	13	155	160	140
304TMA14	304TAA14	14	155	160	140
304TMA17	304TAA17	17	200	260	230
304TMA19	304TAA19	19	200	260	230
304TMA22	304TAA22	22	220	340	300
304TMA24	304TAA24	24	220	340	300
304TMA27	304TAA27	27	245	560	500
304TMA30	304TAA30	30	280	840	750
304TMA32	304TAA32	32	280	840	750
304TMA36	304TAA36	36	290	1180	1050
304TMA41	304TAA41	41	295	1230	1100
304TMA46	304TAA46	46	360	2060	1850
304TMA50	304TAA50	50	360	2230	2000
304TMA55	304TAA55	55	440	2900	2600
304TMA60	304TAA60	60	440	2900	2600

**ТОРЦЕВОЙ Г-ОБРАЗНЫЙ КЛЮЧ** Мод. 0042

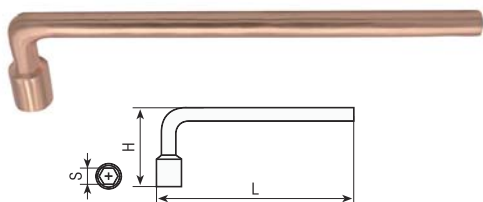

Код		Размер			Вес, г	
Be-Cu	Al-Br	S, мм	L, мм	H, мм	Be-Cu	Al-Br
363TMA6	363TAA6	6	120	29	40	35
363TMA8	363TAA8	8	144	33	70	60
363TMA10	363TAA10	10	168	37	100	90
363TMA12	363TAA12	12	216	42	155	135
363TMA13	363TAA13	13	240	45	215	190
363TMA14	363TAA14	14	245	45	250	215
363TMA15	363TAA15	15	250	48	280	240
363TMA16	363TAA16	16	255	48	335	290
363TMA17	363TAA17	17	260	51	380	325
363TMA18	363TAA18	18	265	53	420	365
363TMA19	363TAA19	19	270	55	460	400
363TMA20	363TAA20	20	272	57	520	450
363TMA21	363TAA21	21	275	57	650	550
363TMA22	363TAA22	22	278	59	750	645
363TMA23	363TAA23	23	282	60	800	680
363TMA24	363TAA24	24	286	63	850	700
363TMA27	363TAA27	27	294	69	900	800
363TMA30	363TAA30	30	302	75	1000	880
363TMA32	363TAA32	32	310	81	1100	950
363TMA36	363TAA36	36	330	85	1300	1150
363TMA41	363TAA41	41	350	90	1500	1380

**КЛЮЧ ТОРЦЕВОЙ Т-ОБРАЗНЫЙ** Мод. 0043

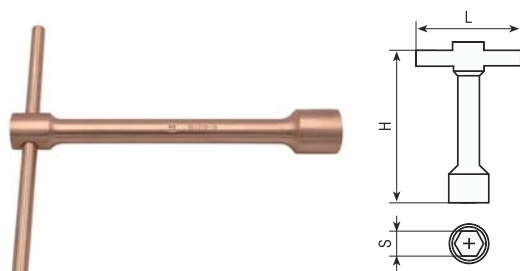

Код		Размер			Вес, г	
Be-Cu	Al-Br	S, мм	L, мм	H, мм	Be-Cu	Al-Br
363TMB7	363TAB7	7	120	120	100	90
363TMB9	363TAB9	9	130	130	155	140
363TMB11	363TAB11	11	140	150	190	170
363TMB14	363TAB14	14	150	170	265	240
363TMB17	363TAB17	17	170	190	410	370
363TMB19	363TAB19	19	180	210	535	480
363TMB22	363TAB22	22	190	240	750	680
363TMB24	363TAB24	24	200	270	950	860
363TMB27	363TAB27	27	200	270	1110	1000
363TMB30	363TAB30	30	200	280	1340	1210
363TMB32	363TAB32	32	200	280	1440	1300
363TMB36	363TAB36	36	200	280	1980	1800

**КЛЮЧ ТОРЦЕВОЙ, ДВОЙНОЙ ИЗОГНУТЫЙ** Мод. 0046

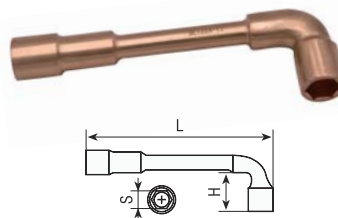

Код		Размер			Вес, г	
Be-Cu	Al-Br	S, мм	L, мм	H, мм	Be-Cu	Al-Br
366TMA6	366TAA6	6	102	18	45	40
366TMA7	366TAA7	7	106	18	50	45
366TMA8	366TAA8	8	114	22	72	65
366TMA9	366TAA9	9	122	22	90	80
366TMA10	366TAA10	10	129	25	130	120
366TMA11	366TAA11	11	136	25	140	125
366TMA12	366TAA12	12	144	28	165	150
366TMA13	366TAA13	13	152	30	200	185
366TMA14	366TAA14	14	160	32	215	195
366TMA15	366TAA15	15	169	35	265	240
366TMA16	366TAA16	16	178	35	325	295
366TMA17	366TAA17	17	187	40	350	315
366TMA18	366TAA18	18	195	40	380	345
366TMA19	366TAA19	19	204	45	485	440
366TMA21	366TAA21	21	221	50	580	525
366TMA22	366TAA22	22	230	50	650	590
366TMA24	366TAA24	24	250	55	705	640
366TMA27	366TAA27	27	280	65	1135	1030
366TMA30	366TAA30	30	310	70	1460	1300
366TMA32	366TAA32	32	330	75	1730	1570
366TMA34	366TAA34	34	350	75	1760	1600
366TMA36	366TAA36	36	370	80	1840	1670

**РАЗВОДНОЙ КЛЮЧ**

Мод. 0050



Код		Размер		Вес, г	
Be-Cu	Al-Br	L, мм	Kmax, мм	Be-Cu	Al-Br
367TM1002	367TA1002	100	13	33	30
367TM1004	367TA1004	150	18	135	120
367TM1006	367TA1006	200	24	281	255
367TM1008	367TA1008	250	30	440	401
367TM1010	367TA1010	300	36	720	655
367TM1012	367TA1012	375	46	1410	1290
367TM1014	367TA1014	450	55	2261	2065
367TM1016	367TA1016	600	65	4705	4301

**КЛЮЧ ТРУБНЫЙ (ШВЕДСКИЙ ТИП), УГОЛ 45°**

Мод. 0058

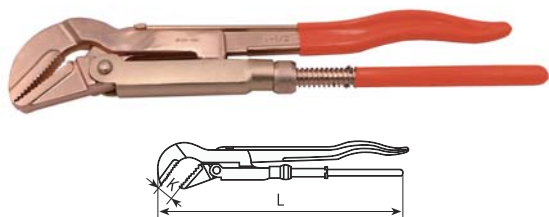

Код		Размер		Вес, г	
Be-Cu	Al-Br	L, мм	K, мм	Be-Cu	Al-Br
360TM1002	360TA1002	420	38	1550	1400
360TM1004	360TA1004	530	50	2230	2000

**КЛЮЧ ТРУБНЫЙ, S-ОБРАЗНЫЙ (ШВЕДСКИЙ ТИП)**

Мод. 0059

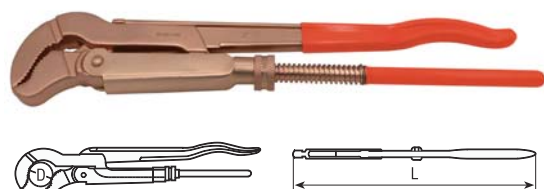

Код		Размер		Вес, г	
Be-Cu	Al-Br	L, мм	D, дюйм	Be-Cu	Al-Br
360TMA1002	360TAA1002	530	2"	2605	2355
360TMA1004	360TAA1004	650	3"	4500	4060
360TMA1006	360TAA1006	790	4"	6200	5600

**КЛЮЧ ТРУБНЫЙ (ШВЕДСКИЙ ТИП), УГОЛ 90°**

Мод. 0060

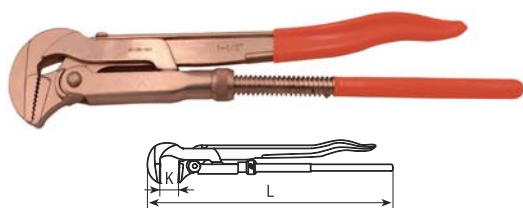

Код		Размер		Вес, г	
Be-Cu	Al-Br	L, мм	K, мм	Be-Cu	Al-Br
360TMB1002	360TAB1002	430	38	1480	1330

**КЛЮЧ ЦЕПНОЙ**

Мод. 0061

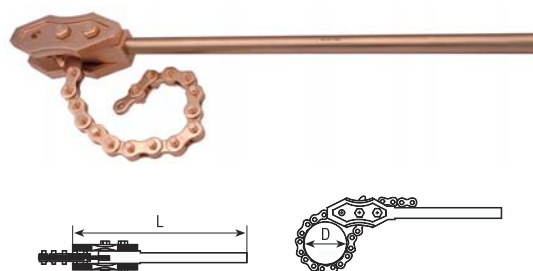

Код		Размер		Вес, г	
Be-Cu	Al-Br	L, мм	Dmax, мм	Be-Cu	Al-Br
368TM1002	368TA1002	600	100	3955	3605
368TM1004	368TA1004	600	150	4650	4200
368TM1006	368TA1006	900	200	8600	7800
368TM1008	368TA1008	900	300	9810	9000

**ТРУБНЫЙ КЛЮЧ**

Мод. 0065

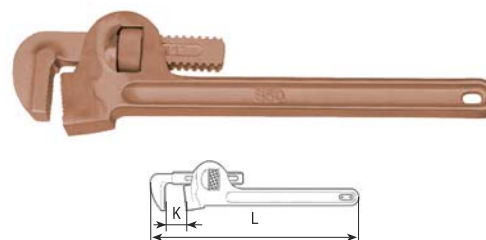

Код		Размер		Вес, г	
Be-Cu	Al-Br	L, мм	Kmax, мм	Be-Cu	Al-Br
345TM1002	345TA1002	200	25	380	345
345TM1004	345TA1004	250	30	580	500
345TM1006	345TA1006	300	40	750	680
345TM1008	345TA1008	350	50	1100	1000
345TM1010	345TA1010	450	60	1785	1625
345TM1012	345TA1012	600	75	3255	2960
345TM1014	345TA1014	900	125	6035	5490
345TM1016	345TA1016	1200	150	12280	10870

**ТРУБНЫЙ КЛЮЧ (АМЕРИКАНСКИЙ ТИП)**

Мод. 0066

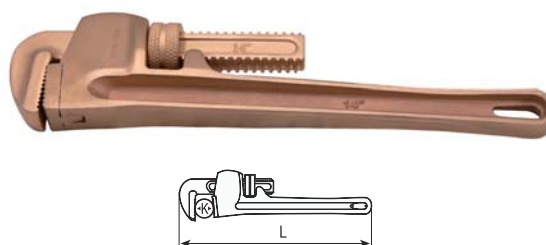

Код		Размер		Вес, г	
Be-Cu	Al-Br	L, мм	Kmax, мм	Be-Cu	Al-Br
343TM1002	343TA1002	200	25	420	380
343TM1004	343TA1004	250	30	735	670
343TM1006	343TA1006	300	40	1050	955
343TM1008	343TA1008	350	50	1315	1195
343TM1010	343TA1010	450	60	2255	2050
343TM1012	343TA1012	600	75	3465	3150
343TM1014	343TA1014	900	85	5880	5345
343TM1016	343TA1016	1200	110	12600	11450

**НАБОР КЛЮЧЕЙ ГАЕЧНЫХ РОЖКОВЫХ ДВУСТОРОННИХ** Мод. 0428



Код		Содержание	
Be-Cu	Al-Br		
TMA9	TAA9	8x10, 10x12, 12x14, 14x17, 17x19, 19x22, 22x24, 24x27, 30x32	9 pcs
TMA10	TAA10	8x10, 10x12, 12x14, 14x17, 17x19, 19x22, 22x24, 24x27, 27x30, 30x32	10 pcs
TMA11	TAA11	8x10, 9x11, 10x12, 12x14, 14x17, 17x19, 19x22, 22x24, 24x27, 27x30, 30x32	11 pcs
TMA12	TAA12	5.5x7, 6x7, 8x10, 9x11,	12 pcs
TMA13	TAA13	10x12, 12x14, 14x17, 17x19, 19x22, 22x24, 24x27, 27x30, 30x32	13 pcs

**НАБОР КЛЮЧЕЙ ГАЕЧНЫХ КОМБИНИРОВАННЫХ** Мод. 0429



Код		Содержание	
Be-Cu	Al-Br		
TMB9	TAA9	8, 10, 12, 14, 17, 19, 22, 24, 27	9 pcs
TMB10	TAA10	10, 12, 14, 17, 19, 22, 24, 27, 30, 32	10 pcs
TMB11	TAA11	8, 10, 12, 14, 17, 19, 22, 24, 27, 30, 32	11 pcs
TMB12	TAA12		12 pcs
TMB13	TAA13	8, 10, 12, 13, 14, 16, 17, 19, 22, 24, 27, 30, 32	13 pcs

**НАБОР КЛЮЧЕЙ ГАЕЧНЫХ НАКИДНЫХ ДВУСТОРОННИХ** Мод. 00431



Код		Содержание	
Be-Cu	Al-Br		
TMC9	TAC9	8x10, 10x12, 12x14, 14x17, 17x19, 19x22, 22x24, 24x27, 30x32	9 pcs
TMC10	TAC10	8x10, 10x12, 12x14, 14x17, 17x19, 19x22, 22x24, 24x27, 27x30, 30x32	10 pcs
TMC11	TAC11	8x10, 9x11, 10x12, 12x14, 14x17, 17x19, 19x22, 22x24, 24x27, 27x30, 30x32	11 pcs
TMC12	TAC12		12 pcs
TMC13	TAC13	5.5x7, 6x7, 8x10, 9x11, 10x12, 12x14, 14x17, 17x19, 19x22, 22x24, 24x27, 27x30, 30x32	13 pcs





2 ГОЛОВКИ ТОРЦЕВЫЕ И ПРИНАДЛЕЖНОСТИ

ГОЛОВКА ТОРЦЕВАЯ ДВЕНАДЦАТИГРАННАЯ, 1/4"

Мод. 0015

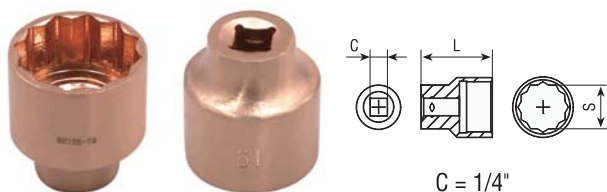

Код		Размер		Вес, г	
Be-Cu	Al-Br	S, мм	L, мм	Be-Cu	Al-Br
356TM4	356TA4	4	25	17	15
356TM4.5	356TA4.5	4.5	25	17	15
356TM5	356TA5	5	25	17	15
356TM5.5	356TA5.5	5.5	25	17	15
356TM6	356TA6	6	25	17	15
356TM7	356TA7	7	25	17	15
356TM8	356TA8	8	25	17	15
356TM9	356TA9	9	25	21	20
356TM10	356TA10	10	25	22	20
356TM11	356TA11	11	25	27	25
356TM12	356TA12	12	26	30	27
356TM13	356TA13	13	26	30	27
356TM14	356TA14	14	26	35	32
356TM15	356TA15	15	27	40	36
356TM16	356TA16	16	27	40	36
356TM17	356TA17	17	27	50	45
356TM18	356TA18	18	27	50	45
356TM19	356TA19	19	27	51	46
Be-Cu	Al-Br	S, дюйм	L, мм	Be-Cu	Al-Br
356TM1002	356TA1002	5/32"	25	14	13
356TM1004	356TA1004	3/16"	25	14	13
356TM1006	356TA1006	7/32"	25	17	15
356TM1008	356TA1008	1/4"	25	17	15
356TM1010	356TA1010	9/32"	25	17	15
356TM1012	356TA1012	5/16"	25	20	18
356TM1014	356TA1014	11/32"	26	24	22
356TM1016	356TA1016	3/8"	26	29	26
356TM1018	356TA1018	7/16"	26	29	26
356TM1020	356TA1020	1/2"	26	29	26

ГОЛОВКА ТОРЦЕВАЯ ДВЕНАДЦАТИГРАННАЯ, 3/8"

Мод. 0016

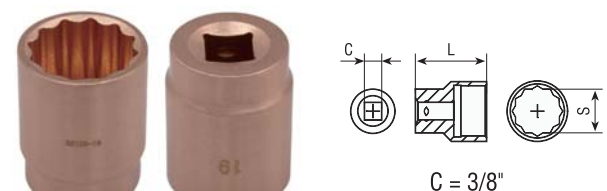

Код		Размер		Вес, г	
Be-Cu	Al-Br	S, мм	L, мм	Be-Cu	Al-Br
354TM5	354TA5	5	28	35	32
354TM5.5	354TA5.5	5.5	28	35	32
354TM6	354TA6	6	28	35	32
354TM7	354TA7	7	28	35	32

354TM8	354TA8	8	28	35	32
354TM9	354TA9	9	32	35	32
354TM10	354TA10	10	32	50	45
354TM11	354TA11	11	32	50	45
354TM12	354TA12	12	32	50	45
354TM13	354TA13	13	32	50	45
354TM14	354TA14	14	32	50	45
354TM15	354TA15	15	32	53	48
354TM16	354TA16	16	32	58	53
354TM17	354TA17	17	32	63	57
354TM19	354TA19	19	32	68	62
354TM20	354TA20	20	32	77	70
Be-Cu	Al-Br	S, дюйм	L, мм	Be-Cu	Al-Br
354TM1002	354TA1002	5/16"	28	35	32
354TM1004	354TA1004	3/8"	28	35	32
354TM1006	354TA1006	7/16"	32	50	45
354TM1008	354TA1008	1/2"	32	50	45
354TM1010	354TA1010	9/16"	32	50	45
354TM1012	354TA1012	5/8"	32	71	65
354TM1014	354TA1014	11/16"	32	72	65
354TM1016	354TA1016	3/4"	32	72	65
354TM1018	354TA1018	13/16"	35	87	80
354TM1020	354TA1020	7/8"	35	104	95
354TM1022	354TA1022	15/16"	35	115	105

ГОЛОВКА ТОРЦЕВАЯ ДВЕНАДЦАТИГРАННАЯ, 1/2"

Мод. 0017

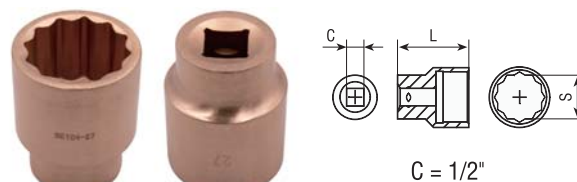

Код		Размер		Вес, г	
Be-Cu	Al-Br	S, мм	L, мм	Be-Cu	Al-Br
351TM6	351TA6	6	40	75	69
351TM7	351TA7	7	40	77	70
351TM8	351TA8	8	40	77	70
351TM9	351TA9	9	40	78	71
351TM10	351TA10	10	40	78	71
351TM11	351TA11	11	40	79	72
351TM12	351TA12	12	40	79	72
351TM13	351TA13	13	40	80	73
351TM14	351TA14	14	40	80	73
351TM15	351TA15	15	40	94	85
351TM16	351TA16	16	40	94	85
351TM17	351TA17	17	40	94	85
351TM18	351TA18	18	42	94	85
351TM19	351TA19	19	42	110	100
351TM20	351TA20	20	42	120	105
351TM21	351TA21	21	43	125	110
351TM22	351TA22	22	43	130	115
351TM23	351TA23	23	43	150	135
351TM24	351TA24	24	43	165	145
351TM25	351TA25	25	43	180	160
351TM26	351TA26	26	43	200	180
351TM27	351TA27	27	46	215	190

351TM28	351TA28	28	46	225	200
351TM29	351TA29	29	46	235	210
351TM30	351TA30	30	46	250	220
351TM32	351TA32	32	46	295	260
Be-Cu	Al-Br	S, дюйм	L, мм	Be-Cu	Al-Br
351TM1002	351TA1002	5/16"	40	70	70
351TM1004	351TA1004	3/8"	40	78	71
351TM1006	351TA1006	7/16"	40	79	72
351TM1008	351TA1008	1/2"	40	80	73
351TM1010	351TA1010	9/16"	40	80	73
351TM1012	351TA1012	5/8"	40	88	80
351TM1014	351TA1014	11/16"	40	93	85
351TM1016	351TA1016	3/4"	42	110	100
351TM1018	351TA1018	13/16"	43	125	110
351TM1020	351TA1020	7/8"	43	130	115
351TM1022	351TA1022	15/16"	43	165	145
351TM1024	351TA1024	1"	43	190	170
351TM1026	351TA1026	1-1/16"	46	215	190
351TM1028	351TA1028	1-1/4"	46	295	260
351TM1030	351TA1030	1-7/16"	50	330	300

357TM1018	357TA1018	1-1/4"	60	437	400
357TM1020	357TA1020	1-5/16"	60	472	430
357TM1022	357TA1022	1-3/8"	60	515	470
357TM1024	357TA1024	1-7/16"	60	525	480
357TM1026	357TA1026	1-1/2"	60	580	530
357TM1028	357TA1028	1-5/8"	65	702	640
357TM1030	357TA1030	1-3/4"	65	761	695
357TM1032	357TA1032	1-13/16"	65	830	705
357TM1034	357TA1034	1-7/8"	65	850	750
357TM1036	357TA1036	2"	70	965	870

**ГОЛОВКА ТОРЦЕВАЯ ДВЕНАДЦАТИГРАННАЯ, 3/4"** Мод. 0018

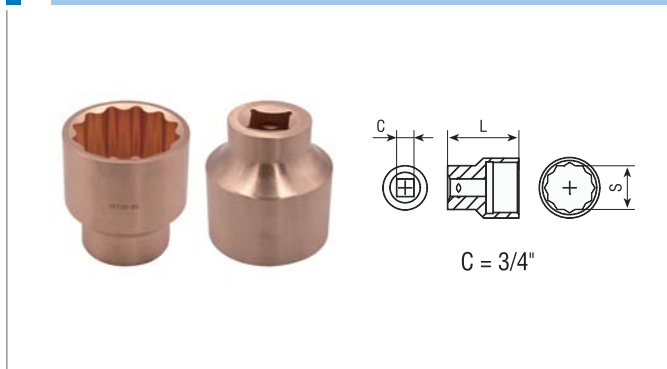

Код		Размер		Вес, г	
Be-Cu	Al-Br	S, мм	L, мм	Be-Cu	Al-Br
357TM17	357TA17	17	50	246	225
357TM19	357TA19	19	50	246	225
357TM21	357TA21	21	55	268	245
357TM22	357TA22	22	55	268	245
357TM23	357TA23	23	55	306	280
357TM24	357TA24	24	55	307	280
357TM26	357TA26	26	55	307	280
357TM27	357TA27	27	55	312	285
357TM28	357TA28	28	55	339	310
357TM29	357TA29	29	55	350	320
357TM30	357TA30	30	60	410	370
357TM31	357TA31	31	60	430	380
357TM32	357TA32	32	60	465	410
357TM34	357TA34	34	60	480	440
357TM36	357TA36	36	60	510	465
357TM38	357TA38	38	60	555	510
357TM41	357TA41	41	65	660	640
357TM46	357TA46	46	65	765	690
357TM50	357TA50	50	70	910	825
Be-Cu	Al-Br	S, дюйм	L, мм	Be-Cu	Al-Br
357TM1002	357TA1002	3/4"	50	240	220
357TM1004	357TA1004	13/16"	55	262	240
357TM1006	357TA1006	7/8"	55	267	245
357TM1008	357TA1008	15/16"	55	305	280
357TM1010	357TA1010	1"	55	310	280
357TM1012	357TA1012	1-1/16"	55	315	285
357TM1014	357TA1014	1-1/8"	55	345	315
357TM1016	357TA1016	1-3/16"	60	400	365

**ГОЛОВКА ТОРЦЕВАЯ ДВЕНАДЦАТИГРАННАЯ, 1"** Мод. 0019

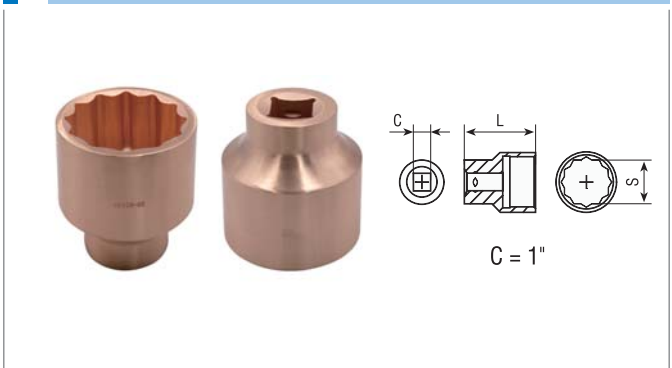

Код		Размер		Вес, г	
Be-Cu	Al-Br	S, мм	L, мм	Be-Cu	Al-Br
359TM22	359TA22	22	55	361	330
359TM24	359TA24	24	55	372	340
359TM25	359TA25	25	55	377	345
359TM26	359TA26	26	55	383	350
359TM27	359TA27	27	55	394	360
359TM28	359TA28	28	55	397	363
359TM29	359TA29	29	55	399	365
359TM30	359TA30	30	60	443	405
359TM31	359TA31	31	60	448	410
359TM32	359TA32	32	60	481	440
359TM34	359TA34	34	60	497	455
359TM36	359TA36	36	65	550	500
359TM38	359TA38	38	65	620	560
359TM41	359TA41	41	70	690	625
359TM46	359TA46	46	75	850	740
359TM50	359TA50	50	75	850	760
359TM55	359TA55	55	80	1160	1000
359TM60	359TA60	60	85	1390	1260
359TM65	359TA65	65	90	1750	1580
359TM70	359TA70	70	90	2150	1950
359TM75	359TA75	75	95	2680	2430
359TM80	359TA80	80	95	3080	2800
Be-Cu	Al-Br	S, дюйм	L, мм	Be-Cu	Al-Br
359TM1002	359TA1002	1-1/16"	55	394	360
359TM1004	359TA1004	1-1/8"	55	398	364
359TM1006	359TA1006	1-3/16"	60	442	405
359TM1008	359TA1008	1-1/4"	60	470	431
359TM1010	359TA1010	1-5/16"	60	483	442
359TM1012	359TA1012	1-3/8"	60	490	448
359TM1014	359TA1014	1-7/16"	65	560	500
359TM1016	359TA1016	1-1/2"	65	620	560
359TM1018	359TA1018	1-5/8"	70	690	625
359TM1020	359TA1020	1-7/8"	75	850	740
359TM1022	359TA1022	2"	75	960	850
359TM1024	359TA1024	2-1/4"	80	1250	1130
359TM1026	359TA1026	2-1/2"	90	1700	1550
359TM1028	359TA1028	2-3/4"	90	2050	1850
359TM1030	359TA1030	3"	95	2750	2500

**ГОЛОВКА С ВНЕШНИМ ШЕСТИГРАННИКОМ**

Мод. 0029

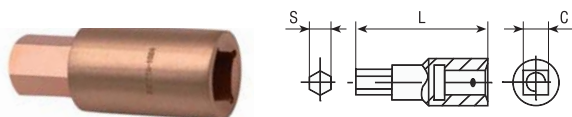

Код		Размер			Вес, г	
Ве-Си	АI-Br	С, дюйм	S, мм	L, мм	Ве-Си	АI-Br
333ТМА1002	333ТАА1002	1/4"	3	55	17	16
333ТМА1004	333ТАА1004		4	55	17	16
333ТМА1006	333ТАА1006		5	55	20	18
333ТМА1008	333ТАА1008		6	55	26	23
333ТМА1010	333ТАА1010		7	55	30	27
333ТМА1012	333ТАА1012		8	65	45	40
333ТМА1014	333ТАА1014		9	65	55	50
333ТМА1016	333ТАА1016		10	65	65	60
333ТМА1018	333ТАА1018		12	60	125	110
333ТМА1020	333ТАА1020		13	60	135	120
333ТМА1022	333ТАА1022	1/2"	14	60	140	125
333ТМА1024	333ТАА1024		15	60	165	145
333ТМА1026	333ТАА1026		16	60	170	150
333ТМА1028	333ТАА1028		17	60	175	160
333ТМА1030	333ТАА1030		18	60	190	170
333ТМА1032	333ТАА1032		19	62	220	200
333ТМА1034	333ТАА1034		20	62	230	205

**ГОЛОВКА ТОРЦЕВАЯ ДЛЯ ТРЕУГОЛЬНЫХ ПРОФИЛЕЙ, 1/2"**

Мод. 0030

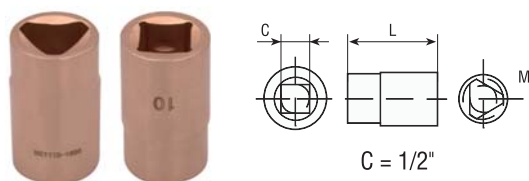

Код		Размер		Вес, г	
Ве-Си	АI-Br	M, мм	L, мм	Ве-Си	АI-Br
333ТМВ1002	AL111B-1002	M6	40	75	70
333ТМВ1004	AL111B-1004	M8	40	80	75
333ТМВ1006	AL111B-1006	M10	40	85	80
333ТМВ1008	AL111B-1008	M12	40	95	90
333ТМВ1010	AL111B-1010	M16	50	180	150
333ТМВ1012	AL111B-1012	M20	50	250	215
333ТМВ1014	AL111B-1014	M24	50	420	380

**ШАРНИРНЫЙ КАРДАН**

Мод. 0032

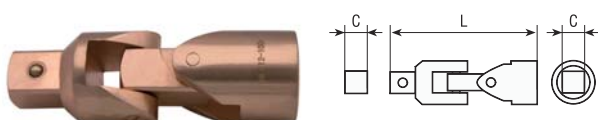

Код		Размер		Вес, г	
Ве-Си	АI-Br	С, дюйм	L, мм	Ве-Си	АI-Br
336ТМ1002	336ТА1002	1/2"	80	186	170
336ТМ1004	336ТА1004	3/4"	110	530	480
336ТМ1006	336ТА1006	1"	132	1000	900

**ПЕРЕХОДНИК**

Мод. 0033

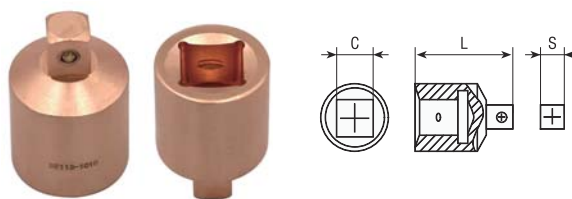

Код		Размер			Вес, г	
Ве-Си	АI-Br	С, дюйм	S, дюйм	L, мм	Ве-Си	АI-Br
334ТМ1002	334ТА1002	3/8"	1/4"	26	31	28
334ТМ1004	334ТА1004	1/4"	3/8"	22	22	20
334ТМ1006	334ТА1006	1/2"	3/8"	34	80	70
334ТМ1008	334ТА1008	3/8"	1/2"	34	60	55
334ТМ1010	334ТА1010	3/4"	1/2"	55	290	260
334ТМ1012	334ТА1012	1/2"	3/4"	50	170	150
334ТМ1014	334ТА1014	1"	3/4"	70	855	770
334ТМ1016	334ТА1016	3/4"	1"	60	360	320
334ТМ1018	334ТА1018	1-1/2"	1"	85	1675	1510
334ТМ1020	334ТА1020	1"	1-1/2"	85	1230	1100

**СКОЛЬЗЯЩИЙ Т-ОБРАЗНЫЙ ВОРОТОК**

Мод. 0036

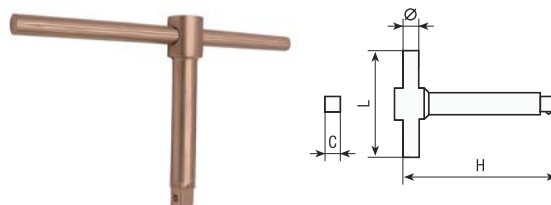

Код		Размер				Вес, г	
Ве-Си	АI-Br	С, дюйм	L, мм	Ø, мм	H, мм	Ве-Си	АI-Br
339ТМ1002	339ТА1002	3/4"	350	19	200	1705	1550
339ТМ1004	339ТА1004	1"	400	21	200	2590	2350

**ВОРОТОК Т-ОБРАЗНЫЙ**

Мод. 0037



Код		Размер				Вес, г	
Ве-Си	АI-Br	С, дюйм	L, мм	Ø, мм	H, мм	Ве-Си	АI-Br
332ТМ1002	332ТА1002	1/2"	250	13	39	340	310
332ТМ1004	332ТА1004	3/4"	350	19	54	1070	960
332ТМ1006	332ТА1006	3/4"	400	21	56	1335	1221
332ТМ1008	332ТА1008	1"	400	21	62	1620	1481

**РУКОЯТКА С ШАРНИРОМ**

Мод. 0038

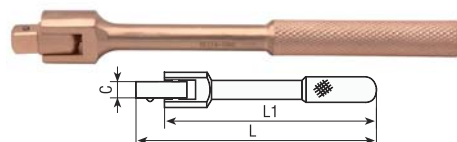

Код		Размер			Вес, г	
Ве-Си	АI-Br	С, дюйм	L, мм	L1, мм	Ве-Си	АI-Br
330ТМ1002	330ТА1002	3/8"	190	175	245	220
330ТМ1004	330ТА1004	1/2"	250	230	440	400
330ТМ1006	330ТА1006	1/2"	320	300	565	510
330ТМ1008	330ТА1008	1/2"	400	380	645	580
330ТМ1010	330ТА1010	3/4"	286	260	635	570
330ТМ1012	330ТА1012	1"	304	270	910	830

338TM1008	338TA1008	1/2"	250	16,5	535	480
338TM1010	338TA1010	3/4"	300	22	1290	1170
338TM1012	338TA1012	1"	300	22	1590	1440

**РУКОЯТКА РЕВЕРСИВНАЯ** Мод. 0040

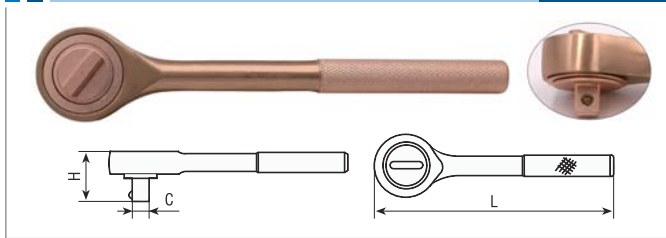

Код		Размер			Вес, г	
Ве-Си	Al-Br	С, дюйм	L, мм	H, мм	Ве-Си	Al-Br
365TM1002	365TA1002	3/8"	200	30	290	260
365TM1004	365TA1004	1/2"	245	43	690	615
365TM1006	365TA1006	3/4"	320	57	1570	1430
365TM1008	365TA1008	1"	550	67	3470	3150

**ВОРОТОК Г-ОБРАЗНЫЙ** Мод. 0041

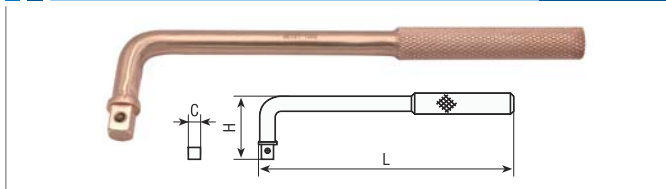

Код		Размер			Вес, г	
Ве-Си	Al-Br	С, дюйм	L, мм	H, мм	Ве-Си	Al-Br
363TM1002	363TA1002	3/8"	200	50	314	287
363TM1004	363TA1004	1/2"	230	60	410	380
363TM1006	363TA1006	3/4"	280	75	765	699
363TM1008	363TA1008	1"	300	85	1160	1060

**УДЛИНИТЕЛЬ** Мод. 0045

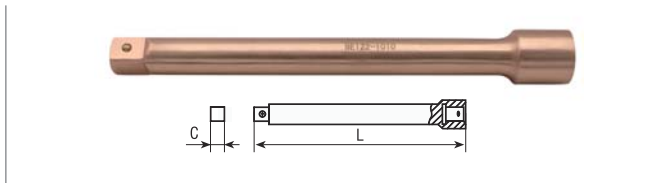

Код		Размер		Вес, г	
Ве-Си	Al-Br	С, дюйм	L, мм	Ве-Си	Al-Br
366TM1002	366TA1002	3/8"	75	93	80
366TM1004	366TA1004	3/8"	150	185	160
366TM1006	366TA1006	1/2"	100	245	225
366TM1008	366TA1008	1/2"	125	260	230
366TM1010	366TA1010	1/2"	200	365	330
366TM1012	366TA1012	1/2"	250	470	425
366TM1014	366TA1014	3/4"	200	855	770
366TM1016	366TA1016	1"	200	1525	1380

**КОЛОВОРОТ 1/2"** Мод. 0047

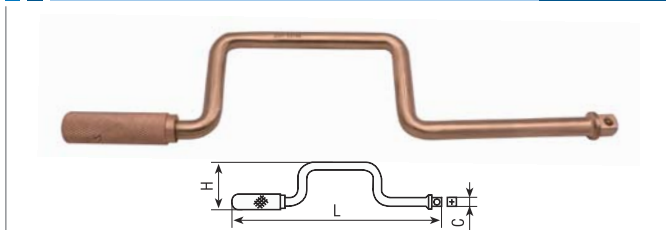

Код		Размер			Вес, г	
Ве-Си	Al-Br	С, дюйм	L, мм	H, мм	Ве-Си	Al-Br
364TM1002	364TA1002	1/2"	390	96	780	700

**РУКОЯТКА ПРЯМАЯ 1/4"** Мод. 0048



Код		Размер			Вес, г	
Ве-Си	Al-Br	С, дюйм	L, мм	L1, мм	Ве-Си	Al-Br
361TM1002	361TA1002	1/4"	163	55	95	85

### 3 ШАРНИрно-ГУБЦЕВЫЙ ИНСТРУМЕНТ

#### ПАССАТИЖИ

Мод. 0315

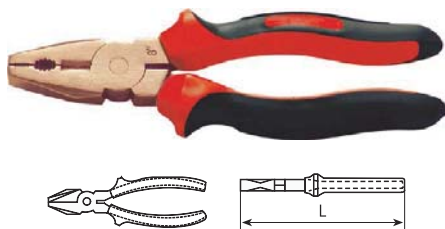

Код		Размер		Вес, г	
Ве-Су	АI-Вr	L, дюйм	L, мм	Ве-Су	АI-Вr
619TM1002	619TA1002	6"	150	180	165
619TM1004	619TA1004	7"	175	355	330
619TM1006	619TA1006	8"	200	465	435
619TM1008	619TA1008	10"	250	550	500

#### ПАССАТИЖИ УСИЛЕННЫЕ

Мод. 0316

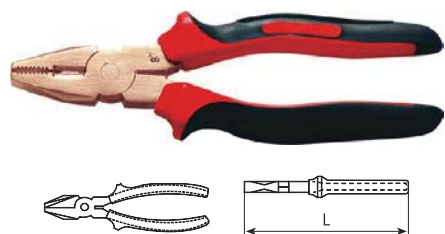

Код		Размер		Вес, г	
Ве-Су	АI-Вr	L, дюйм	L, мм	Ве-Су	АI-Вr
612TM1002	612TA1002	8"	200	470	420

#### БОКОРЕЗЫ УСИЛЕННЫЕ

Мод. 0318



Код		Размер		Вес, г	
Ве-Су	АI-Вr	L, дюйм	L, мм	Ве-Су	АI-Вr
610TMA1002	610TAA1002	6"	150	175	155
610TMA1004	610TAA1004	8"	200	225	205

#### КЛЕЩИ

Мод. 0320

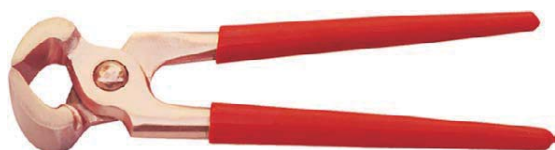

Код		Размер		Вес, г	
Ве-Су	АI-Вr	L, дюйм	L, мм	Ве-Су	АI-Вr
618TM1002	618TA1002	8"	200	325	300

#### КЛЕЩИ УСИЛЕННЫЕ

Мод. 0321



Код		Размер		Вес, г	
Ве-Су	АI-Вr	L, дюйм	L, мм	Ве-Су	АI-Вr
618TMA1002	618TAA1002	7"	175	250	225

#### ПЛОСКОГУБЦЫ

Мод. 0323

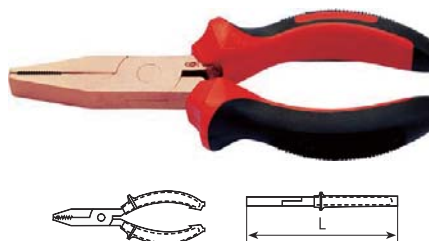

Код		Размер		Вес, г	
Ве-Су	АI-Вr	L, дюйм	L, мм	Ве-Су	АI-Вr
675TM1002	675TA1002	6"	150	200	185
675TM1004	675TA1004	8"	200	281	257

#### КЛЕЩИ ПЕРЕСТАВНЫЕ

Мод. 0324

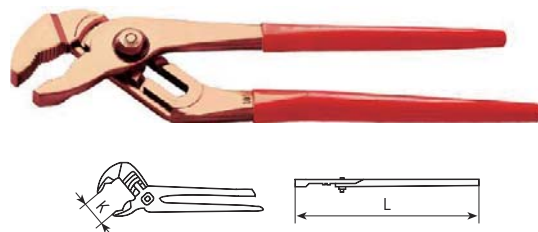

Код		Размер			Вес, г	
Ве-Су	АI-Вr	L, дюйм	L, мм	Ктах, мм	Ве-Су	АI-Вr
673TM1002	673TA1002	6"	150	25	180	160
673TM1004	673TA1004	10"	250	45	425	370
673TM1006	673TA1006	12"	300	55	670	600
673TM1008	673TA1008	14"	350	55	850	770

#### КЛЕЩИ ПЕРЕСТАВНЫЕ С КОРОБЧАТЫМ ШАРНИРОМ

Мод. 0325

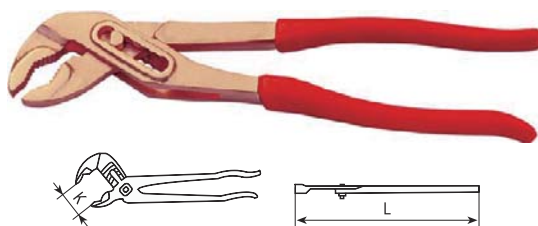

Код		Размер			Вес, г	
Ве-Су	АI-Вr	L, дюйм	L, мм	Ктах, мм	Ве-Су	АI-Вr
676TM1002	676TA1002	10"	250	32	365	335

**КЛЕЩИ ПЕРЕСТАВНЫЕ** Мод. 0326



Код		Размер			Вес, г	
Ве-Су	АI-Вr	L, дюйм	L, мм	Ктах, мм	Ве-Су	АI-Вr
676ТМА1002	676ТАА1002	10"	250	32	325	310
676ТМА1004	676ТАА1004	12"	300	52	665	610

**ПЛОСКОГУБЦЫ** Мод. 0327



Код		Размер			Вес, г	
Ве-Су	АI-Вr	L, дюйм	L, мм	Ктах, мм	Ве-Су	АI-Вr
674ТМ1002	674ТА1002	6"	150	54	190	170
674ТМ1004	674ТА1004	8"	200	74	335	300

**ПЛОСКОГУБЦЫ УДЛИНЕННЫЕ** Мод. 0328



Код		Размер			Вес, г	
Ве-Су	АI-Вr	L, дюйм	L, мм	Ктах, мм	Ве-Су	АI-Вr
671ТМ1002	671ТА1002	6"	150	54	190	170
671ТМ1004	671ТА1004	8"	200	74	335	300

**КРУГЛОГУБЦЫ** Мод. 0329

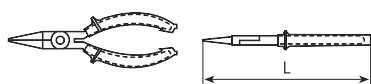

Код		Размер		Вес, г	
Ве-Су	АI-Вr	L, дюйм	L, мм	Ве-Су	АI-Вr
677ТМ1002	677ТА1002	6"	150	190	175

**ТИСКИ РУЧНЫЕ** Мод. 0336



Код		Размер			Вес, г	
Ве-Су	АI-Вr	L, дюйм	L, мм	D, мм	Ве-Су	АI-Вr
672ТМД1002	672ТАД1002	10"	225	40	480	455

**НОЖНИЦЫ ЖЕСТЯНЩИКА** Мод. 0308

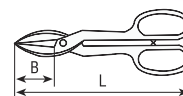

Код		Размер		Вес, г	
Ве-Су	АI-Вr	L, мм	B, мм	Ве-Су	АI-Вr
611ТМ1002	611ТА1002	300	75	488	410

**КРОВЕЛЬНЫЕ НОЖНИЦЫ ПО МЕТАЛЛУ** Мод. 0310

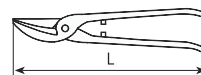

Код		Размер	Вес, г	
Ве-Су	АI-Вr	L, мм	Ве-Су	АI-Вr
611ТМВ1002	611ТАВ1002	280	500	450



## ОТВЕРТКА ШЛИЦЕВАЯ

Мод. 0343

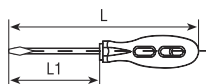

Код		Размер			Вес, г	
Ве-Сu	Al-Br	L1, мм	L, мм	В, мм	Ве-Сu	Al-Br
695TM1002	695TA1002	50	134	3	35	33
695TM1004	695TA1004	50	134	4.5	43	40
695TM1006	695TA1006	75	159	3	35	32
695TM1008	695TA1008	75	159	4	45	42
695TM1010	695TA1010	75	180	5	70	65
695TM1012	695TA1012	10	184	4	45	42
695TM1014	695TA1014	10	205	5	75	70
695TM1016	695TA1016	100	215	6	85	80
695TM1018	695TA1018	125	240	6	100	95
695TM1020	695TA1020	150	265	6	110	105
695TM1022	695TA1022	150	265	7	125	120
695TM1024	695TA1024	150	277	8	140	135
695TM1026	695TA1026	200	327	8	165	155
695TM1028	695TA1028	250	377	9	185	175
695TM1030	695TA1030	250	377	11	260	245
695TM1032	695TA1032	300	427	10	245	230
695TM1034	695TA1034	300	427	11	290	275
695TM1036	695TA1036	350	477	11	320	300
695TM1038	695TA1038	400	550	12	450	430
695TM1040	695TA1040	450	600	13	485	450

## ОТВЕРТКА КРЕСТОВАЯ

Мод. 0344

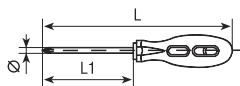

Код		Размер			Вес, г	
Ве-Сu	Al-Br	L1, мм	L, мм	Size	Ве-Сu	Al-Br
693TM1002	693TA1002	50	134	PH0	35	32
693TM1004	693TA1004	75	159	PH1	70	63
693TM1006	693TA1006	100	205	PH1	75	70
693TM1008	693TA1008	125	240	PH2	100	95
693TM1010	693TA1010	150	265	PH2	110	105
693TM1012	693TA1012	200	327	PH3	165	155
693TM1014	693TA1014	250	377	PH3	185	170
693TM1016	693TA1016	300	427	PH4	245	230
693TM1018	693TA1018	350	477	PH4	270	255
693TM1020	693TA1020	400	550	PH4	295	280
693TM1022	693TA1022	450	600	PH4	320	300

## ОТВЕРТКА КРЕСТОВАЯ PZ

Мод. 0349

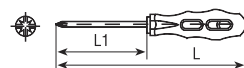

Код		Размер				Вес, г	
Ве-Сu	Al-Br	L1, дюйм	Size	L, мм	L1, мм	Ве-Сu	Al-Br
691TM1002	691TA1002	2	PZ0	50	134	35	33
691TM1004	691TA1004	3	PZ1	75	159	45	42
691TM1006	691TA1006	4	PZ2	100	220	85	80
691TM1008	691TA1008	6	PZ3	150	277	145	135
691TM1010	691TA1010	8	PZ4	200	327	230	210

## ОТВЕРТКА ТИПА TORX

Мод. 0468

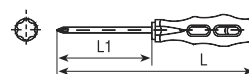

Код		Размер			Вес, г	
Ве-Сu	Al-Br	Size	L1, мм	L, мм	Ве-Сu	Al-Br
691TMA1002	691TAA1002	TX10	75	180	70	63
691TMA1004	691TAA1004	TX15	75	180	70	63
691TMA1006	691TAA1006	TX20	100	215	100	95
691TMA1008	691TAA1008	TX25	125	240	105	100
691TMA1010	691TAA1010	TX30	150	265	110	100
691TMA1012	691TAA1012	TX40	200	327	165	155
691TMA1014	691TAA1014	TX45	250	377	185	175
691TMA1016	691TAA1016	TX50	300	427	205	195
691TMA1018	691TAA1018	TX55	350	477	245	225
691TMA1020	691TAA1020	TX60	400	527	280	255



**МОЛОТОК С КВАДРТНЫМ БОЙКОМ** Мод. 0181



Код		Размер		Вес, г	
Be-Cu	Al-Br	L, мм	H, (head)	Be-Cu	Al-Br
309TM1002	309TA1002	310	500	655	
309TM1004	309TA1004	340	1000	1175	
309TM1006	309TA1006	400	1500	1850	
309TM1008	309TA1008	400	2000	2455	
309TM1010	309TA1010	700	3000	3700	
309TM1012	309TA1012	900	5000	6000	

**МОЛОТОК С КВАДРТНЫМ БОЙКОМ** Мод. 0182



Код		Размер		Вес, г	
Be-Cu	Al-Br	L, мм	H, (head)	Be-Cu	Al-Br
309TMA1002	309TAA1002	310	500	655	
309TMA1004	309TAA1004	320	1000	1175	
309TMA1006	309TAA1006	360	1500	1850	
309TMA1008	309TAA1008	380	2000	2455	
309TMA1010	309TAA1010	700	3000	3700	
309TMA1012	309TAA1012	800	5000	6000	

**КУВАЛДА** Мод. 0191



Код		Размер		Вес, г	
Be-Cu	Al-Br	L, мм	H, (head)	Be-Cu	Al-Br
383TM1002	383TA1002	310	450	610	
383TM1004	383TA1004	400	1000	1300	
383TM1006	383TA1006	400	1400	1700	
383TM1008	383TA1008	400	1500	1800	
383TM1010	383TA1010	400	1800	2100	
383TM1012	383TA1012	400	2000	2300	
383TM1014	383TA1014	400	2200	2500	
383TM1016	383TA1016	700	2500	3210	
383TM1018	383TA1018	700	2700	3410	
383TM1020	383TA1020	700	3000	3710	
383TM1022	383TA1022	700	3600	4310	
383TM1024	383TA1024	900	4000	4910	
383TM1026	383TA1026	900	4500	5410	
383TM1028	383TA1028	900	5000	5910	

383TM1030	383TA1030	900	335	5400	6310
383TM1032	383TA1032	900	370	6400	7310
383TM1034	383TA1034	900	375	7200	8110
383TM1036	383TA1036	900	400	8000	8910
383TM1038	383TA1038	900	445	8200	9110
383TM1040	383TA1040	900	445	9100	10010
383TM1042	383TA1042	900	485	9900	10810

**КУВАЛДА** Мод. 0195



Код		Размер		Вес, г	
Be-Cu	Al-Br	L, мм	Be-Cu	Al-Br	
383TMВ1002	383ТАВ1002	310	450		
383TMВ1004	383ТАВ1004	320	1000		
383TMВ1006	383ТАВ1006	360	1400		
383TMВ1008	383ТАВ1008	360	1500		
383TMВ1010	383ТАВ1010	380	1800		
383TMВ1012	383ТАВ1012	380	2000		
383TMВ1014	383ТАВ1014	400	2200		
383TMВ1016	383ТАВ1016	400	2500		
383TMВ1018	383ТАВ1018	400	2700		
383TMВ1020	383ТАВ1020	700	3000		
383TMВ1022	383ТАВ1022	700	3600		
383TMВ1024	383ТАВ1024	800	4000		
383TMВ1026	383ТАВ1026	800	4500		
383TMВ1028	383ТАВ1028	800	5000		
383TMВ1030	383ТАВ1030	800	5400		
383TMВ1032	383ТАВ1032	800	6400		
383TMВ1034	383ТАВ1034	900	7200		
383TMВ1036	383ТАВ1036	900	8000		
383TMВ1038	383ТАВ1038	900	8200		
383TMВ1040	383ТАВ1040	900	9100		
383TMВ1042	383ТАВ1042	900	9900		

**ЗУБИЛО** Мод. 0261

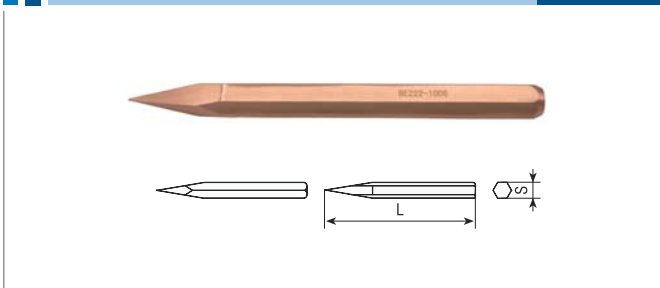

Код		Размер		Вес, г	
Be-Cu	Al-Br	S, мм	L, мм	Be-Cu	Al-Br
666TM1002	666TA1002	14	150	165	155
666TM1004	666TA1004	18	200	385	355
666TM1006	666TA1006	20	250	610	555
666TM1008	666TA1008	20	300	725	660



**БОРОДОК** Мод. 0263



Код		Размер		Вес, г	
Ве-Сu	Al-Br	L, мм	Ø, мм	Ве-Сu	Al-Br
664TMA1002	664TAA1002	150	5	235	215
664TMA1004	664TAA1004	150	8	285	255
664TMA1006	664TAA1006	150	10	345	315

**ЦИЛИНДРИЧЕСКАЯ ВЫКОЛОТКА** Мод. 0264

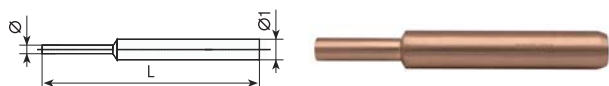

Код		Размер			Вес, г	
Ве-Сu	Al-Br	Ø, мм	Ø1, мм	L, мм	Ве-Сu	Al-Br
664TMB1002	664TAB1002	3	9	110	20	15
664TMB1004	664TAB1004	4	10	110	57	50
664TMB1006	664TAB1006	6	12	115	105	95
664TMB1008	664TAB1008	8	14	120	130	115
664TMB1010	664TAB1010	10	16	145	200	180
664TMB1012	664TAB1012	12	18	160	280	260
664TMB1014	664TAB1014	14	20	180	410	380
664TMB1016	664TAB1016	16	24	200	640	600
664TMB1018	664TAB1018	18	30	225	1070	960
664TMB1020	664TAB1020	20	32	225	1230	1110

**БОРОДОК** Мод. 0265

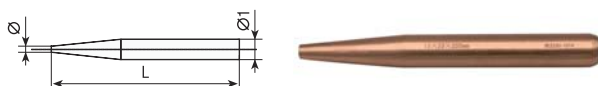

Код		Размер			Вес, г	
Ве-Сu	Al-Br	Ø, мм	Ø1, мм	L, мм	Ве-Сu	Al-Br
664TMC1002	664TAC1002	5	11	150	105	95
664TMC1004	664TAC1004	6	12	150	130	115
664TMC1006	664TAC1006	7	13	150	150	135
664TMC1008	664TAC1008	8	14	150	170	150
664TMC1010	664TAC1010	10	16	175	255	230
664TMC1012	664TAC1012	12	18	175	335	300
664TMC1014	664TAC1014	13	29	255	1180	1060

**БОРОДОК ПУТЕВОЙ** Мод. 0266



Код		Размер		Вес, г	
Ве-Сu	Al-Br	L, мм	Ø, мм	Ве-Сu	Al-Br
664TMD1002	664TAD1002	160	18	290	265
664TMD1004	664TAD1004	250	18	470	425
664TMD1006	664TAD1006	300	18	600	545
664TMD1008	664TAD1008	300	20	700	635
664TMD1010	664TAD1010	300	25	1100	995
664TMD1012	664TAD1012	400	18	800	725
664TMD1014	664TAD1014	400	20	1000	885

**БОРОДОК** Мод. 0267

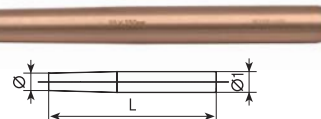

Код		Размер			Вес, г	
Ве-Сu	Al-Br	Ø, мм	Ø1, мм	L, мм	Ве-Сu	Al-Br
664TME1002	664TAE1002	8	11	150	125	118
664TME1004	664TAE1004	10	13	150	155	140
664TME1006	664TAE1006	12	15	150	215	190
664TME1008	664TAE1008	14	18	200	420	380
664TME1010	664TAE1010	15	19	200	435	390
664TME1012	664TAE1012	16	20	200	480	435
664TME1014	664TAE1014	17	21	200	570	540
664TME1016	664TAE1016	18	22	250	600	560
664TME1018	664TAE1018	19	23	250	860	780
664TME1020	664TAE1020	20	24	250	875	790
664TME1022	664TAE1022	21	25	250	950	885
664TME1024	664TAE1024	22	26	250	965	920
664TME1026	664TAE1026	24	28	250	1270	1150
664TME1028	664TAE1028	25	29	250	1300	1170
664TME1030	664TAE1030	26	30	250	1390	1250
664TME1032	664TAE1032	27	31	300	1900	1770

**КРЕЙЦМЕЙСЛЬ** Мод. 0273

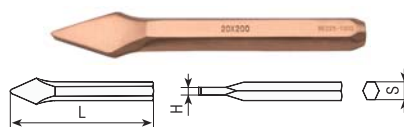

Код		Размер			Вес, г	
Ве-Сu	Al-Br	S, мм	L, мм	H, мм	Ве-Сu	Al-Br
667TM1002	667TA1002	20	200	8	475	432

**КРЕЙЦМЕЙСЛЬ ПЛОСКИЙ** Мод. 0274



Код		Размер			Вес, г	
Ве-Сu	Al-Br	S, мм	B, мм	H, мм	Ве-Сu	Al-Br
667TMA1002	667TAA1002	140	4	6	280	255
667TMA1004	667TAA1004	200	4	7	480	435
667TMA1006	667TAA1006	300	5	8	840	760

**ЗУБИЛО ПЛОСКОЕ** Мод. 0283

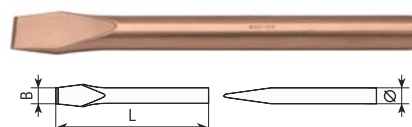

Код		Размер			Вес, г	
Ве-Сu	Al-Br	L, мм	Ø, мм	B, мм	Ве-Сu	Al-Br
643TM1002	643TA1002	160	14	14	175	160
643TM1004	643TA1004	160	16	16	231	210
643TM1006	643TA1006	160	18	18	295	271

643TM1008	643TA1008	200	18	18	382	342
643TM1010	643TA1010	200	20	20	473	430
643TM1012	643TA1012	250	24	24	822	751
643TM1014	643TA1014	300	24	24	1025	942
643TM1016	643TA1016	300	25	25	1302	1002
643TM1018	643TA1018	400	25	25	1502	1360
643TM1020	643TA1020	500	25	25	1903	1730
643TM1022	643TA1022	500	30	30	2730	2481

**ЗУБИЛО ШЕСТИГРАННОЕ** Мод. 0284



Код		Размер			Вес, г	
Be-Cu	Al-Br	S, мм	L, мм	B, мм	Be-Cu	Al-Br
646TM1002	646TA1002	10	150	12	98	92
646TM1004	646TA1004	14	200	16	251	231
646TM1006	646TA1006	16	160	18	262	242
646TM1008	646TA1008	14	250	16	320	302
646TM1010	646TA1010	17	300	19	772	701
646TM1012	646TA1012	17	350	19	903	821
646TM1014	646TA1014	22	600	24	1861	1702
646TM1016	646TA1016	25	300	28	1204	1090
646TM1018	646TA1018	30	500	35	2860	2620



ЛОМ

Мод. 0291

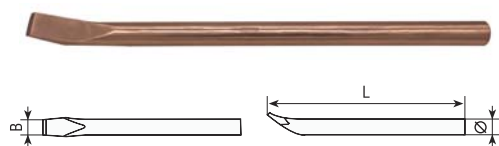

Код		Размер			Вес, г	
Ве-Су	АI-Br	L, мм	Ø, мм	H, мм	Ве-Су	АI-Br
642TM1002	642TA1002	500	15	15	738	675
642TM1004	642TA1004	500	19	19	1150	1050
642TM1006	642TA1006	500	20	20	1295	1185
642TM1008	642TA1008	500	25	25	1975	1805
642TM1010	642TA1010	500	30	30	2925	2675
642TM1012	642TA1012	600	25	25	2380	2175
642TM1014	642TA1014	600	30	30	3450	3155
642TM1016	642TA1016	800	23	23	2290	2095
642TM1018	642TA1018	800	25	25	3175	2905
642TM1020	642TA1020	800	30	30	4490	4105
642TM1022	642TA1022	850	30	30	4870	4455
642TM1024	642TA1024	1000	25	25	3985	3645
642TM1026	642TA1026	1000	28	28	4710	4305
642TM1028	642TA1028	1000	30	30	5595	5115
642TM1030	642TA1030	1200	25	25	4795	4385
642TM1032	642TA1032	1200	30	30	6970	6375
642TM1034	642TA1034	1500	30	30	8665	7925

ЛОМ

Мод. 0292

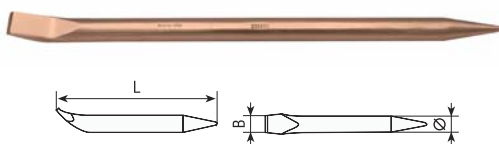

Код		Размер			Вес, г	
Ве-Су	АI-Br	L, мм	Ø, мм	H, мм	Ве-Су	АI-Br
642TMA1002	642TAA1002	500	15	16	672	615
642TMA1004	642TAA1004	500	19	20	1093	1001
642TMA1006	642TAA1006	500	20	20	1148	1052
642TMA1008	642TAA1008	500	23	23	1481	1355
642TMA1010	642TAA1010	600	25	25	2132	1950
642TMA1012	642TAA1012	800	23	23	2530	2293
642TMA1014	642TAA1014	1000	30	28	5193	4752

ШПАТЕЛЬ

Мод. 0225



Код		Размер			Вес, г	
Ве-Су	АI-Br	K, мм	L, мм	L1, мм	Ве-Су	АI-Br
654TMA1002	654TAA1002	25	200	90	75	90
654TMA1004	654TAA1004	40	200	90	95	115
654TMA1006	654TAA1006	50	200	90	105	120
654TMA1008	654TAA1008	65	200	90	115	125

ШПАТЕЛЬ

Мод. 0231

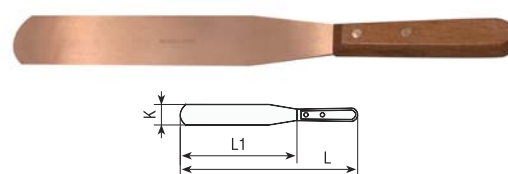

Код		Размер			Вес, г	
Ве-Су	АI-Br	K, мм	L, мм	L1, мм	Ве-Су	АI-Br
651TMD1002	651TAD1002	40	350	230	120	110

ШПАТЕЛЬ

Мод. 0232



Код		Размер			Вес, г	
Ве-Су	АI-Br	K, мм	L, мм	L1, мм	Ве-Су	АI-Br
651TME1002	651TAE1002	75	200	95	100	165
651TME1004	651TAE1004	100	200	95	105	195
651TME1006	651TAE1006	150	250	145	215	310

НАБОР НАПИЛЬНИКОВ, 5 ШТ.

Мод. 0260



Код	Размер	Вес, г	
Ве-Су	L, мм	Ø, мм	Ве-Су
663TMA	180	5	140

НОЖ

Мод. 0221

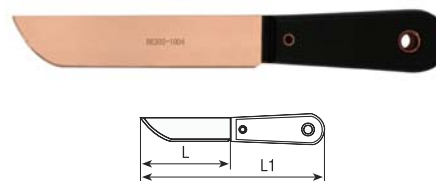

Код		Размер		Вес, г	
Ве-Су	АI-Br	L, мм	L1, мм	Ве-Су	АI-Br
656TM1002	656TA1002	80	185	90	105
656TM1004	656TA1004	145	250	105	125

**НОЖ** Мод. 0234

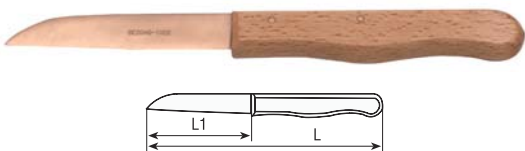

Код		Размер		Вес, г	
Be-Cu	Al-Br	L, мм	L1, мм	Be-Cu	Al-Br
651TMG1002	651TAG1002	180	75	90	120

**ШИЛО** Мод. 0355

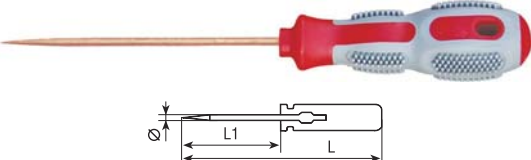

Код		Размер				Вес, г	
Be-Cu	Al-Br	L1, дюйм	L1, мм	Ø, мм	L, мм	Be-Cu	Al-Br
698TM1002	698TA1002	4	100	3	184	50	45

**ЦИРКУЛЬ** Мод. 0356

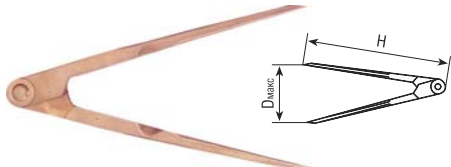

Код		Размер		Вес, г	
Be-Cu	Al-Br	Dmax, мм	H, мм	Be-Cu	Al-Br
698TMA1002	698TAA1002	200	200	170	150
698TMA1004	698TAA1004	400	400	400	360

**ОТВЕС** Мод. 0204

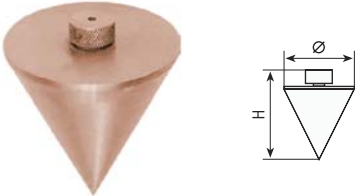

Код		Размер		Вес, г	
Be-Cu	Al-Br	H, мм	Ø, мм	Be-Cu	Al-Br
384TM1002	384TA1002	59	50	275	247

**ЩЕТКА** Мод. 0378

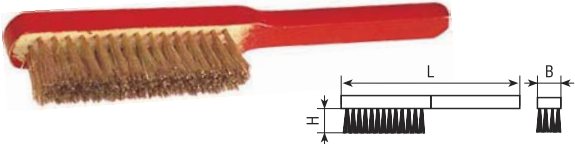

Код		Размер			Вес, г	
Phosphor Copper	Brass	LxB, мм	Ряды	H, мм	Ph-Cu	Brass
285TM1002	285TA1002	290x29	4x16	28	115	115

**ЩЕТКА** Мод. 0380

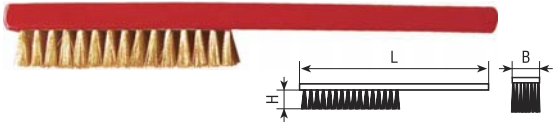

Код		Размер			Вес, г	
Phosphor Copper	Brass	LxB, мм	Ряды	H, мм	Ph-Cu	Brass
286TM1002	286TA1002	215x29	6x15	15	30	30

**СКОБА ТАКЕЛЖНАЯ** Мод. 0402

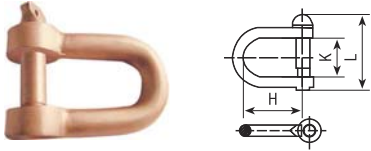

Код		Размер				Вес, г	
Be-Cu	Al-Br	Size	K, мм	L, мм	H, мм	Be-Cu	Al-Br
686TM1002	686TA1002	1/2	30	60	40	135	130
686TM1004	686TA1004	3/4	37	99	78	915	830



## НАБОР ГОЛОВОК ТОРЦЕВЫХ 1/2", 13 шт.

Мод. 0006



Код		Содержание
Be-Cu	Al-Br	
353TMF	353TAF	Головка 8, 10, 11, 12, 14, 17, 19, 22, 24 и 27 мм Рукоятка реверсивная 1/2", 245 мм Вороток с шарниром 1/2", 250 мм

## НАБОР ГОЛОВОК ТОРЦЕВЫХ 1/2", 17 шт.

Мод. 0007



Код		Содержание
Be-Cu	Al-Br	
353TMG	353TAG	Головка 10, 11, 12, 14, 17, 19, 22, 24, 27, 30 и 32 мм Рукоятка реверсивная 1/2", 245 мм Т-образный вороток 1/2", 250 мм Коловорот 1/2", 400 мм Удлинитель 1/2", 125 мм и 250 мм





Lined writing area with 25 horizontal lines.



**teho**

# teho

ИСКРОБЕЗОПАСНЫЙ  
КОРРОЗИОННОСТОЙКИЙ  
НЕМАГНИТНЫЙ  
ПРОМЫШЛЕННЫЙ  
ИНСТРУМЕНТ

 **UNIOR®**

ООО «Униор Профешнл Тулз»  
196105, Санкт-Петербург,  
ул. Благодатная, д. 63, корпус 1  
тел./факс: (812) 449-83-50, 449-83-51  
e-mail: unior@unior.ru  
www.unior.ru

 **СОЛИОН**  
ИНЖЕНЕРНО-ПРОЕКТАРНО-ИНСТРУМЕНТАЛЬНАЯ КОМПАНИЯ

ООО «СОЛИОН»  
196105, Санкт-Петербург,  
ул. Благодатная, д. 63, корпус 1, лит. Д  
тел./факс: (812) 449-83-53, 449-83-54  
e-mail: sales@solion.ru  
www.solion.ru

Звонки из России: 8-800-700-83-51

